

KATHY GUILBEAU shows the new payment system at the Cameron Waterworks office. Closed circuit TV and a vacuum tube delivery system allow her to communicate with customers in the drive-through below. (Photo by Cyndi Sellers.)



Thomas McDaniel



Bryon Richard



Richard Toerner

McDaniel is candidate for P. Juror

Thomas McDaniel, age 44, has announced his candidacy for District 4 Police Juror serving the Grand Chenier/Klondike/Lowery/East Creole/Little Chenier/Chenier Perdue areas of Cameron Parish.

Thomas is a lifelong resident of Cameron Parish currently residing in Creole. He is married to Deborah Baccigalopi McDaniel and they have two children, Brittany and Cody.

He is the owner of Cameron Rental and Tank of Cameron and Fourchon, and Mac's Classic Muscle Cars.

Thomas has served as a past member of the Cameron Parish Economic Development Board. He has been a local supporter of Cameron Parish and South Cameron High School for many years.

He has been a corporate sponsor of South Cameron Athletics, sponsor of boys and girls summer softball league teams.

Thomas was a coach for the Stars and Stripes girls softball team. He has received several awards from Cameron Parish schools and organizations for his contributions to Cameron Parish.

Richard is running in District 6

Lifelong resident of Cameron, Bryon K. "Goose" Richard, has announced his candidacy for Police Juror District 6.

Bryon is married to Carla Howerton and they have three children, Jodi who resides in Lake Charles and Bryon and Brady who live in Baton Rouge.

Richard has worked for Cameron Construction and Crain Brothers all of his adult life. He is currently executive vice-president of Crain Brothers of Grand Chenier.

He is a member and Trustee of Our Lady Star of the Sea Catholic Church and was instrumental in rebuilding the church after the storm. He serves as Board Member for the Cameron Fire District No. 1, and recently was named to the Community Advisory Panel of Cheniere Energy. He is a charter member of the Citizens for the Recovery of Cameron Parish and served in the past as board member for Gravity Drainage No. 3.

Toerner is announcing for P. Juror

Announcing for the Dist. 3 Police Jury seat is Richard E. Toerner, a resident of Grand Lake for over 30 years.

He and his wife of 38 years, Sally, have four children and six grandchildren.

Mr. Toerner served in the U. S. Army during the Vietnam War.

He retired from the U. S. Post Office after 35 years of service and where he was union steward eight years. He also served as vice president of the local union two years.

He coached girls softball eight years and served on South Lake Charles ASA Softball board of directors six years, two as president.

Water office to hold grand opening

By CYNDI SELLERS

Cameron Water and Wastewater District has reopened its office at 126 Ann Street after remodeling its

damaged but not destroyed structure. Superintendent Edward Peterson said enough of the building remained after Hurricane Rita to allow it to be reused.

One change made was to raise the office area inside the building to 13 feet above sea level. Now, customers can pay their bills by using a drive-through vacuum canister system like those at banks. The clerk can see the customers on closed circuit camera.

Customers may also walk upstairs and meet with staff in person. Kathy Guilbeau welcomes the public to visit and see the new office and to sign up for door prizes for the grand opening.

The Grand Opening celebration for the new office is set for Thursday, Sept. 27, from 10 a.m. to 4 p.m. Door prizes will be given throughout the day. Winners need not be present on the day. Customers and friends are invited to come throughout the day to see the building and visit with staff and board members.



Karen Nunez

Nunez is candidate for S. Board

Karen Faulk Nunez has announced her candidacy for the District 7 School Board seat in the Oct. 20 election.

Mrs. Nunez has been married to Jessie Nunez 35 years and they are parents of Jennifer, director of religious education at New Iberia High School, and Eric; grandchildren are Eric, Jr., and Hunter Nunez.

A 1972 graduate of Grand Lake High School, Mrs. Nunez is a graduate of New York State College of Nursing. She is director of perioperative surgery at Women and Children's Hospital in Lake Charles.

She is a member of St. Mary of the Lake Catholic Church where she serves as a lector.

Mrs. Nunez served on the Cameron Parish School Board 1990-98 and was president 1996-98.

Boustany to be in Cam. Friday

Congressman Charles Boustany and State Director USDA Rural Development Clyde Holloway will be in Cameron Friday, Sept. 14, to present significant grant funding to five parish fire districts.

Receiving these grants will be Fire Protection District 7, Creole; No. 9, Grand Chenier; No. 10, Johnson Bayou; No. 14, Grand Lake; and Hackberry.

Grant funds will be used to purchase two new ladder trucks, a pumper truck, an apparatus truck, an emergency response system and vehicle, a command post trailer, new equipment for existing trucks and associated fire fighting equipment.

Representatives of the five fire districts will be on hand for the presentation at 2 p.m. at the Johnson Bayou Fire Department, 155 Berwick Road.

USDA Rural Development provides project funding to support increasing economic opportunity and improving the quality of life for rural residents.

The public is invited to attend this good news event.

Pilot offers information on political ads

With political campaigns gearing up for the Oct. 20 election, the Pilot offers the following information regarding ads and announcements:

Advertising space reservation and copy deadline for each week is Monday, 5 p.m., for the week an ad is scheduled to run. Political advertisements require pre-payment.

The Pilot will not run any announcements the week of the election or the week before.

Announcements are run on a first-come basis.



Cam. Parish School Board announces bids for schools

By CYNDI SELLERS

The Cameron Parish School Board is moving forward in hurricane recovery, one step at a time. At its regular meeting Monday afternoon in Creole, the Board awarded bids for athletic lockers and athletic field restrooms, concession stand, and press box for South Cameron High School. The Board also agreed to move forward on replacing the SCHS and Johnson Bayou tracks and upgrading the Hackberry and Grand Lake tracks to rubberized surfaces.

Shannon Smith Construction was low bidder on the athletic field projects, at \$352,400. Hahn Enterprises was low bidder for the lockers at \$48,191. The Board will advertise for the track work.

The Board also agreed to purchase electronic surveillance equipment for the older section of Grand Lake School, Hackberry School, and South Cameron School, to be funded through various means. Johnson Bayou has a new surveillance system already.

MISPLACED LEVEE

Representatives of the U. S. Army Corps of Engineers presented a report to the Board detailing the incursion onto the School Board's section 16-13-10, adjacent to the Sabine Refuge. A containment dike for a beneficial spoil placement project was inadvertently built in the wrong place, enclosing 15.5 acres of school property.

The Corps is offering to pay the Board for an easement on the property, since

removing the dike and rebuilding it in the right place would be very expensive, and there is not enough money in the CWPPRA project budget to cover it.

Hackberry School Board member Dwayne Sanner countered with two proposals: either leave the dike where it is and build another one in the right place, or trade the affected 15.5 acres for a 40-50 acre tract of refuge property on the other side of the section.

The representatives said they would look into the proposals, but were doubtful they could be approved.

BUDGET ADOPTED

The 2007-08 budget was adopted. Board Accountant Margaret Jones pointed out

Cont. on Page 4.



SHYLIN NUNEZ received a certificate from the Cameron Parish School Board recognizing her for receiving the \$10,500 Horatio Alger Louisiana Scholarship. Shylin was a 2007 valedictorian at South Cameron High School. Shown are: School Board President Loston McEvers, Nunez, Board members Dot Theriot, Patty Morris, and Marvin Trahan. (Photo by Cyndi Sellers.)



Julie Burleigh

J. Burleigh is running for S. Board

Julie Burleigh of Cameron announces her candidacy for Cameron Parish School Board, District 6.

Mrs. Burleigh has worked in the school system as a class aide and substitute for 20 years and has been involved as an elementary cheerleader sponsor, 4-H leader for five years, involved with the PTA at Cameron Elementary, a member of SCHS Athletic Asso., helped with organizing events for children to help better their education.

She has also participated in the Sheriff's Softball Program, coaching and umpiring in the organization, and supporting children of the parish.

Originally from Westlake, where she graduated in 1977 and married her husband of 30 years, Kirk, she is the mother of three children: Erik Burleigh of Moss Bluff; Jenny Bono of Grand Lake; and Lucas Burleigh, attending NTCC of Mount Pleasant, Tex. The three grandchildren are Trenton Bono, attending pre-K at GLHS, and Dylan and Brianna Burleigh of Moss Bluff.

She is a member of Our Lady Star of the Sea Church in Cameron and was a catechism teacher for several years.



FRANK THOMPSON and his son, Levi, of Frank Thompson Studio of Gillis are shown working on the stained glass windows of St. Peter the Apostle Catholic Church in Hackberry. The first Masses in the church since being damaged by Hurricane Rita in 2005 will be held Saturday, Sept. 15 and Sunday, Sept. 16. (Photo by Ken Shearman/American Press.)

Funerals



JOSEPH MARTIN KERSHAW

Joseph Martin Kershaw, 55, of Carlyss, died Sunday, Sept. 9, 2007 in a Lake Charles Hospital. He was a native of Hackberry and a resident of Carlyss for the past two years. He was a Catholic and retired as a heavy equipment operator.

He was preceded in death by his father, Abel Kershaw.

Survivors include his wife, Terry Nelson Kershaw of Carlyss; two sons, Ronnie Kershaw and wife Jill of LeBleu Settlement and Gerald Kershaw and wife Sarah of Moss Bluff; one daughter, Julie Vincent and husband Jared of Sulphur; his mother, Irene Kershaw of Hackberry, one brother, Roland Kershaw; one sister Mary Jean Marnich of Lake Charles; and six grandchildren.

His funeral was held Sept. 11, in Robison Funeral Home. Johnny Mounce officiated. Burial was in Dutch Cove Cemetery under the direction of Robison Funeral Home in Sulphur.

JAMES B. CURRIE

James B. "Jimmy" Currie, 64, of Carlyss, died Saturday, Sept. 8, 2007, in a local hospital.

He was a native of Orange, Tex. and had been a resident of the Sulphur area for the last 50 years. He was a 1961 graduate of Sulphur High School. He played professional baseball, last with the Chicago White Sox organization and many years fastpitch softball. He retired as an equipment operator with Vista Chemical Company after 25 years of service.

Survivors include his wife, Nell J. Currie of Carlyss; three daughters, Tanya Williams and Kellie Couvillion and husband Bobby of Lake Charles and Nicole Sellers and husband Garon of Hackberry, three sisters, Pansy Oberly of Willis, Tex. and Margaret Entis and Pawnee cody of Spring, Tex. and seven grandchildren.

He was preceded in death by his parents, Allen and Mable Currie.

His funeral was held Tuesday, Sept. 11 at Hixson-Sulphur Memorial Funeral Home. Pastor Rick McClain officiated. Burial was in Mimosa Pines Cemetery South in Carlyss.

LYNN P. MCCALL

Lynn P. McCall, 90, of Grand Chenier, died Friday, Sept. 7, 2007, in his residence.

He was born in Grand Chenier and had lived there most of his life. He was a graduate of LSU with a bachelor's in animal husbandry.

He was a World War II Army Veteran and a cattleman, and he was retired from Amoco Production.

Preceding him in death were his parents, Thomas and Marie McCall; two sons, Joe Lynn McCall and Jeff Robert McCall; brother, Robert "Bob" McCall; and sister, Fae Jones.

Survivors include his wife, Betty C. McCall; son, Thomas McCall of Magnolia, Tex. three daughters, Jamie McCall of Los Lunas, N. M. Jean McCall of Albuquerque, N. M. and Ruby McCall of Asheville, N. C., two sisters, Vergie LeBleu of Lake Charles, and Sybil McCall of Cameron; and two grandchildren.

His funeral was held Monday, Sept. 10, in Hixson Funeral Home. Burial was in McCall Cemetery in Grand Chenier. The Rev. Wallace Primeaux officiated.

JAMES FREDDY MAYS WING

James Freddy Mays Wing, 62, of Carlyss, died Saturday, Sept. 8, 2007, in his home.

He graduated from Sulphur High School in 1963 and was employed as a pipefitter and welder through Plumbers and Steamfitters Local 106.

He was preceded in death by his parents, Melvin Tick and Carrie Maye Mays Wing.

Survivors include his wife, Katherine Bauch Wing of Carlyss; one daughter, Wendy Williamson and husband Tim of Welsh and one son, John Wing of Carlyss; one brother, Melvin Wing Jr. of Hackberry; three sisters, Ramona Wing of Rockwall, Tex., Karen Wing of Sulphur, and Evelyn Wing of Carlyss; and four grandchildren.

His funeral was held Monday, Sept. 10, at the Robison Funeral Home Chapel. Bob Goodner officiated. His body was donated to science as per his wishes.

In lieu of flowers, donations may be sent to M. D. Anderson Cancer Center, P. O. Box 4486, Houston, TX 77210-4486.



JOHNSON BAYOU High School students competed in their local World's best rice cookery contest held by Mrs. Reesa Boudreaux and the FACS classes. Students shown are Dylan Morrison, Kaitlin Billiot, Winner: Morgan Leger, Marcus Fontenot, and runner up, Blake Badon.

Beach Sweep to be held Saturday

By **CYNDI SELLERS**

The annual Beach Sweep will be held in Cameron Parish this Saturday, Sept. 15. Local stores have offered to serve as pick up sites for bags and data cards, in absence of beach captains for each beach, according to Nat Griffith, parish coordinator.

Participants are asked to tally the types and amount of trash on the data cards and return them to the store, where they will be collected and the data compiled for the whole parish. Bagged trash will be picked up at the beach by parish crews.

Participating stores are: Rutherford Beach - Creole One-Stop and Carroll's Quick Stop; Johnson Bayou beaches - Bayou Convenience Store.

Volunteers should bring their own supplies, including sunscreen, water, gloves, and insect repellent. They should stay on the sand, not go into the grass, for safety. Potentially hazardous materials should not be handled.

The weather promises to be good, making Beach Sweep a nice outing for the whole family and a fun way to help the environment at the same time. The most unusual item found will be announced next week.

Griffith hopes to have more beach captains and more group participation by next year. To volunteer or for more information, he can be reached at 569-2484.

GED classes in Grand Lake

The Cameron Community Action Alliance Agency is presently offering GED study courses under their Adult Education Program. The GED is the General Education Development program that represents the alternate High School Diploma.

Committed and motivated students can complete their GED study courses in 10-13 weeks. Course schedules and hours are made to fit the student's needs. Courses are taught by a certified teacher with instruction being small group or one-on-one. The minimum attendance is at least 6 hours per week. Tuition is free and the courses are offered to anyone ages 16 or older.

Classes are held in Grand Lake next to the U. S. Post Office. If you feel that this program is for you then find out by calling Lana Miller at 598-5158.

Volunteers needed

The Fur and Wildlife Festival tradition is in extreme jeopardy due to the lack of an adequate number of volunteers.

The Fur and Wildlife Festival Board asks that everyone who wants to keep this Cameron Parish tradition alive to attend their next meeting on Sept. 23, at 3 p.m. at the Creole Fire Station.



Johnson Bayou High School News

MEETINGS SCHEDULED

Tuesday, Sept. 18 there will be a PTO meeting at 5:30 p.m. Members can sign up for PTO at this meeting. Anyone wishing to vote in the election of officers for PTO will need to be present for two meetings prior to the November election meeting. The Athletic Association meeting will follow at 6:15 p.m.

MEET THE REBELS

Meet The Rebel Night, also held on Sept. 18, will begin in the gym at 7 p.m. The entire community is invited to come out and support the Rebels as they embark on this year's basketball season.

On Thursday, Sept. 20 there will be many important events during the school day. Junior Achievement Day will be held for the second grade. Chevron will be present to hold Career Day for Junior and Senior students of Johnson Bayou.

There will be a Junior High boys and girl's basketball game held in the Johnson

Bayou High School gym on Sept. 20.

BOX TOPS CONTEST

A Box Tops for Education Contest was held at Johnson Bayou High School this week. The winning classes were 7th grade with 327 box tops; 4th grade with 128; and 8th grade with 65.

The students of these grades will receive a cookie and punch reward next week. JBHS students should continue to collect box tops as there will be additional contests announced later on in the month.

LA 82 lane to be closed

One lane of La 82 Mermentau River bridge will be closed to traffic on Tuesday Sept. 18 and Wednesday Sept. 19 from 8 a.m. to 5 p.m.

This closure is necessary for bridge inspection.

-The CAMERON PILOT-
(USPS 150-200)
Telephones: (337)786-8004 or (337)786-2870

Jerry and Joy Wise, Editors & Publishers; Jeffra Wise DeViney, Advertising Manager; Shirley Johnson, Production Manager; Julie Fletcher, Crystal Nix, Tina Poole, Dustin Royer, and Dawn Spears, Staff Members

The Cameron Pilot, 110 Asa St., P.O. Box 1486, Cameron, La. 70631. Published Weekly. Entered as periodical mail at DeQuincy, La. Post Office, Periodical Postage paid.

POSTMASTER: Send address changes to: The Cameron Pilot, P.O. Box 995, DeQuincy, La. 70633.

Subscription Rates: \$23.00 a year (tax included) in Cameron & Calcasieu Parishes; \$25.40 elsewhere in La., \$33.60 elsewhere in USA.

8-1-1

WHEN IT COMES TO DIGGING SAFELY, YOU MAKE THE CALL

Whether you're working on a large excavation or simply planting a tree in your yard, natural gas and utility line safety should always be job one—and that starts with calling 8-1-1 to have your utility lines marked. By doing so, you can be certain where your electric, gas, water and other important lines are located as well as avoid causing serious injuries, service interruptions or possibly costly fines for damaged infrastructure. Make the call. Respect the lines. Dig with care. After all, safety is in your hands... but always on our mind.

For more information on natural gas safety, visit CenterPointEnergy.com.

CenterPoint Energy

Always There.®

Thib's Electrical

Electrical Contractor
State License #45542
Bonded & Insured

- Residential & Commercial
- Remodels & Service Work

— FREE ESTIMATES —
Danny Thibodeaux, Owner

(337) 661-1071 Email: thibselectric@gmail.com

The **Cameron Pilot**

Customer Services

Complete the appropriate section(s) below and mail entire coupon to: **THE CAMERON PILOT, P.O. Box 995, DeQuincy, La. 70633-0995**
Allow Two Weeks For Processing.

Change of Address?

If You're Planning A Move, Please Attach Your Newspaper Label Here, Then Print Your Name and Address In The Box Below. Send Early To Ensure Continuous Service.

Easy Renewal

To Renew Your Current Subscription, Please Check The Appropriate Box Below, Then Print Your Name and Address In The Box Below.

Cameron & Calcasieu Parish.....\$23.00

Elsewhere In Louisiana & Texas.....\$25.40

Elsewhere In The United States.....\$33.60

Want Advertising Info?

Please Check The Box Below and Print Your Name and Address In The Section Below.

Yes. Please Send Me Advertising Rate Information.

Name and Address

Be Sure To Complete This Section In Addition To Any of The Sections You've Filled In Above.

From: _____

Name _____

Address _____

City _____ State _____ Zip _____

Don't Forget To Include Your Payment For Your Subscription.

Gift Idea

The Cameron Pilot Makes a Welcome Gift. And It's So Easy To Give. Simply Fill Out The Recipient's Name and Address Below, Then Print Your Name and Address In The Box Above. Rates same as in Easy Renewal.

Name _____

Address _____

City _____ State _____ Zip _____

(For More Than One Gift, Please Attach A Separate Sheet.)



Mr. and Mrs. Jesse Nunez

Nunez-Bourque vows are said in Bell City

Ann Marie Bourque and Jesse Alan Nunez were married July 28, at 2 p.m. at the St. John Vianney Catholic Church in Bell City. The Father Albert Borel officiated the ceremony. Jeffery Cormier provided the music.

Parents of the couple are Kenneth and Martha Bourque of Lacassine and Rodrick and Tamara Nunez of Grand Lake.

Given in marriage by her father, the bride wore an ivory gown with a semi-cathedral train, all hand beaded. Her veil was shoulder length and ivory beaded.

Menieca LaFosse served as the matron of honor and Mandie Bourque served as the maid of honor. Bridesmaids included Lauren

Broussard, Carey Richard, Kristen Borne, Amelia Beech and Baylee Bourque. The attendants wore taupe tea length dresses with chocolate accents.

The flower girl and ring-bearer were Audreanna Richard and Derek Huval.

Bestmen were Bryant Nunez and Armand "Bubba" Richard and groomsmen included Craig Domingue, Michael Brasseaux, Scott Crochet, Corey Kelly and Jarrett Nunez.

Ushers were Braun Bourque, Martin Bourque, Cody McDaniel and Todd Connor

A reception followed in the Lacassine Optimist Club Community Center.

The bride is a graduate of Lacassine High School and McNeese State University. The groom is employed by Expeditors and Production Services Company Inc.

The couple is making their home in Creole.

Grandparents of the bride are Ray and Martha Breaux of DeQuincy, Ms. Joyce Bourque of Hayes and the late L. J. Bourque. Grandparents of the groom are Curtis and Virgie Nunez of Creole and Ray and Cora Hendrix of Grand Lake.

Redeemed! in concert

Hackberry First Baptist Church will present Redeemed! in concert Sunday, Sept. 16 at 6 p.m.

Refreshments will be served. Everyone is invited to attend.

South Cameron High School News

SPIRIT SALES SCHS

Spirit t-shirts are on sale in the school office. They are \$10 each. Roster t-shirts can be purchased from Ms. Oralia Benoit. Tarpon license plates are \$15 and can be purchased by contacting the school office.

JUNIOR CLASS FUNDRAISER

The Junior class is selling Tarpon backpacks (red bag with royal print) \$15; Tarpon beach towel (white towel w/ red and royal print) \$20; Tarpon blanket (grey fleece blanket with red and royal print) \$20. Contact any Junior or the school office to purchase these items.

HOMECOMING NEWS

Homecoming Court consists of:

Senior maids - Kaley Boudoin, Rachael Fountain, Chynna Little, Erika Pickett, Kami Savoie and Victoria Wilkerson;

Junior maids - Kimily Bourriaque and Haley McCall;

Sophomore maids - Kelsey Mudd and Shelby Willis;

Freshman maids - Kristen Broussard and Jadah Primeaux;

Eighth grade maids: Taylor Canik and Breanne DeBarge.

Homecoming will take place on Friday, Oct. 5. Classes of 1998, 1983 and 1958 will be honored at a pregame reception beginning at 5 p.m. in the school gym.

CLUB NEWS

4-H dues are \$10 and must be paid by Sept. 17. Beta dues are \$20 and must be paid by Sept. 14. FBLA dues are \$20 and must be paid by Sept. 27.

DANCE LINE CAMP

Come and join the SCHS Danceline, "Tarpon Dazzlers," as they host the Annual Elementary Dance Camp to be held on Saturday, Oct. 20, at South Cameron High School in the gym. Cost will be \$35 per participant. Registration will be at 8:30 a.m. with a final presentation at 3 p.m. Camp is open to grades K-8th.

Participants are to bring a sack lunch (drinks will be provided).

All participants will receive a danceline t-shirt and will perform at half time for the South Cameron vs Oberlin game to be on Friday, Oct. 26. Forms will be sent home at SCHS, but if there are any little girls from the other area schools wishing to attend, please contact Sharon Picou at SCHS 542-4628 or 542-4860. Forms will be due back by Tuesday, Oct. 9.

COUNSELOR NEWS

ACT deadline is Sept. 21 for the Oct. 27 test date.

SCHOOL CALENDAR

Sept. 13 - JV Football at Kinder; Progress Reports

Sept. 14 - Football Kinder (home) 7 p.m.

Sept. 17 - Graduates Sales meet with Seniors 9 a.m.; Juniors will follow

Sept. 20 - JV Football at Lake Arthur

Sept. 21 - Football Lake Arthur (home) 7 p.m.

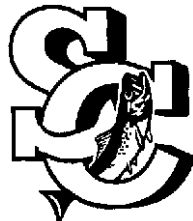

Tarps
chomp
Jackets!
Go
Team!



NIKI CROCHET and Cody Fenetz announce their engagement and forthcoming marriage. The wedding is set for Saturday, Sept. 29 at Our Lady of Prompt Succor Catholic Church in Sulphur at 1 p.m. The bride-elect is the daughter of Ms. Judy Duddleston and Mr. and Mrs. Valmond Crochet, all of Creole. The groom-elect is the son of Tony and Kelli Fenetz of Hackberry.



TARPON FANS were all dressed out in Tarpon red for the first home game of the South Cameron Tarpons since Hurricane Rita hit two years ago. The Tarpons rewarded their fans with a victory over DeQuincy.

Propane Service



FOR HOMES BEYOND THE GAS MAINS

- Tanks
- Space Heaters
- Gas Heaters
- Gas Logs

LAKE ARTHUR BUTANE CO.

- New Location -
2329 E. McNeese St.
Lake Charles

1-800-256-1287
or 439-4051
Established 1945

Happy Ads

ARE HERE AGAIN!!



- Birthday
- Anniversary
- Promotion
- League Championship
- Graduation
- New Baby
- Bon Voyage
- Good Luck
- Engagement
- Wedding
- New Home

Price Includes Photo and Art-Work. Mail your request along with photo and payment by 4 p.m. Monday to P. O. Box 995, DeQuincy, La. 70633. Ads must be signed.

Place A Happy Ad For As Little As **\$22⁵⁰**

Congratulations! You've found a terrific way to send your best wishes to someone special for any occasion!

The Cameron Pilot

Call or come by now and make someone's day!
786-8004 or Toll Free: 1-800-256-7323

We Appreciate Our Customers.

YOU



You're Invited to Customer Appreciation Day!

We invite all Cameron Communications customers to join us for pizza, drinks, giveaways and some great door prizes.

Cameron
Cameron Courthouse
Wednesday, September 12, 5 p.m.-7p.m.

Johnson Bayou
Johnson Bayou High School Gym
Tuesday, September 25, 5 p.m.-7p.m.

So make some time to stop by and let us give a proper "thank you" for letting Cameron Communications serve you and your community.



Cameron Communications

Get connected.

1 800 737-3900

www.camtel.com



MARGARET PITTS of Hackberry took her Cameron Pilot to Rockaway Beach, Missouri, to share the news with Beulah and Clyde Bradley.

Volunteers needed for G.L. Livestock Advisory Board

Anyone interested in serving on behalf of the Grand Lake Community on the 2007-08 Cameron Parish Livestock Advisory Board, please attend the meeting on Thursday, Sept. 13, in the Grand Lake High School Ag Room at 5 p.m.



Accounting Tips For Small Business Owners

Tips and strategies for managing your business financials and reporting

- Business structures
- Employee or Independent Contractor?
- Financial Reports
- What records to keep and why

Presented by the
IMPCAL and
Louisiana Small Business Development Center
McNeese State University

Thursday, September 20, 2007

Grand Lake High School
School Library

4:00 p.m. - 7:00 p.m.

FREE/ Includes Snacks

Pre-register by phoning (337) 475-5529 or
email LSBDC.MSU@lsbdc.org

USDA United States Department of Agriculture



Special arrangements for handicapped individuals will be made with reasonable prior notification.
McNeese State University is a member of the University of Louisiana Systems
EQAAA/AOA

LETTER TO THE EDITOR

New ordinance infringes on Cameron Parish heritage

Dear Editor:

My name is Paul E. Toerner a resident of Cameron Parish. I was born on Oct. 1, 1926 at Chenier Pardue, mother Eucharist Theriot, father Earl Toerner.

I am writing this letter because I feel our present sheriff and the Cameron Parish Police Jury are taking out our heritage (creole living) by the last ordinance posted recently, by not allowing any road shoulder parking in Cameron Parish, with a fine of up to \$900 plus 30 days in jail.

This ordinance was pushed by our sheriff who informed the jury that three (3) children had been killed while crabbing. I have been a subscriber of the Pilot for at least 20 years and I do not recall any of these accidents. Maybe these dates should be available before such action is taken. I have checked with the editor and he stated that has not happened in the last ten years. Why such a ordinance now? I have fished and crabbed all my life, taught by my grandfather, aunts, and uncle as a way of life for food and recreation.

I have parked to crab, fish and hunt all these years and never been given a ticket by the previous sheriff, Mr. Sono Savoie. Why now? I have taught my children, grand children and great-grandchildren to do this.

Does the sheriff have no feeling for the heritage? The nature trail is advertised a lot, maybe they should come and see but don't stop as you will be given a ticket. I know most of our deputies and they are kind and respectful and helpful. Why force them to stop a recreation that is good and healthy for our children?

Ebenezer plans Prayer Service

On Monday, Sept. 24 the Ebenezer Baptist Church will hold their usual Monday night Prayer Service in Cameron on their church grounds, in observance of the 2nd Anniversary of Hurricane Rita.

The church family has been borrowing a church in Lake Charles to hold their Worship services since the storm.

The public is invited. The services will begin at 6 p.m. until 7 p.m. Please bring your lawn chairs.

For further information, contact Viola Ball at 249-9029.



Wake up residents of Cameron, this is one of many of our rights and heritage that is being taken away from all of us. Where will the hunters park to hunt ducks and deers which are plentiful.

Come back home to Cameron Parish but live by our decision. No fishing, no hunting, and God knows how high to build your home, if you can afford this.

One "incident" recently, my granddaughter was crabbing near Gibbstown Hwy, a Deputy stopped and asked how they got there, she answered that she was brought there by her husband, then asked how she was going back. I'll call on my cell phone for him to pick us up. He replied you will get a ticket. Is this still a free country, with soldiers dying each day to protect our freedom.

People from nearby towns have called about this no parking, why, as long as you are 18 inches or more from the edge of pavement it is legal by law if it doesn't interfere with traffic. Maybe the speed limit should be lowered to protect our people enjoying a great recreational time.

Please vote and exercise your rights to enjoy life as it was before.

Sincerely,
/s/ Paul Toerner

SCHOOL BOARD Cont. from Pg. 1

that the budget, which shows a \$75,000 surplus, contains a number of variable items such as FEMA payments and construction expenses that could change. Revisions may have to be made in the next few months as more information becomes available, she said.

One positive point was that the Tax Assessor has reported overall property assessments up by \$36 million in the parish.

OTHER BUSINESS

The Board authorized Lee Bloch, of Bloch, Briggs, and Associates to pursue several items relating to oil and gas lease and royalty payments on school sections. The firm is under contingency contract to audit the oil and gas incomes.

Superintendent Stephanie Rodrigue announced that the Junior Achievement program will be instituted for grades 1-5 in all parish school this year, underwritten by Cheniere Energy. Junior Achievement is a civics, free enterprise and economics program. The kick-off will be Thursday, Sept. 20, at 10 am at Johnson Bayou School.

The Board agreed to amend its admission policy to allow children to enroll if they are living with a sibling, aunt or uncle at least 21 years of age. Previously the sibling had to be married, and there was no age limit on the aunt or uncle.

A proposal by Cameron board member Marvin Trahan to prohibit "Crocs" or other rubberized shoes in school was tabled, pending more input from school administrators. Trahan said the shoes were dangerous for children to run in at PE and slippery in the halls when wet. Others said they are an inexpensive shoe, and no more dangerous than other approved ones.



Grand Chenier Library tells coming events

The following is a schedule of coming events for Grand Chenier Library

Thursday, Sept. 13, "Everyone's Hero", Movie time Rated G-87 min., 11 a.m., "Sweatin' to the Oldies" with Richard Simmons, 2 p.m., "After School Club", 4 p.m.,

Friday, Sept. 14, "La. Spirit Hurricane Recovery", Arts & Crafts, 1-3 p.m.

Monday, Sept. 17, "Sweatin' to the Oldies" with Richard Simmons, 2 p.m.

Tuesday, Sept. 18, "Sweatin' to the Oldies" with Richard Simmons, 2 p.m.

Wednesday, Sept. 19, "Sweatin' to the Oldies" with Richard Simmons, 2 p.m.

Thursday, Sept. 20, "Elmocize" exercise program with Elmo, 11 a.m., "Sweatin' to the Oldies" with Richard Simmons, 2 p.m., "After School Club", 4 p.m.

Friday, Sept. 21, "La. Spirit Hurricane Recovery", Arts & Crafts, 1-3 p.m.

Anyone interested in Crochet or Genealogy Classes, please call to have your name put on the list for future classes.

Please call 538-2214 for more details.

Firearm safety course set at H'berry center

Cameron Sheriffs Office will be holding a firearms safety course Friday Oct. 19, 6 p.m. at the Hackberry Community Center. The course will be open to women of Cameron Parish 18 and older.

Time will run 2 to 3 hours. Attendance is limited to the first 20 that register. Course will provide a better understanding of firearms, safety, basic handling and address concerns and questions.

On Oct. 20, at 10 a.m. course participants will have the opportunity to shoot firearms at the Sheriff's Office range in Cameron. Both must be attended to shoot. Registration forms are available in the Sheriff's Office at the Courthouse in Cameron and the Substation in Hackberry.

For questions contact Instructor, Deputy French at 762-3962 or 775-5111.



B & L Spray Foam Insulation

Specializing in:
INSUL-SOY

Soybean Based Open & Closed Cell Spray Foam

- Spray Foam for New Homes • Re-Models & Upgrades
- Storage Buildings • Under Floor of Elevated Homes
- Coolers • Vessel Ice Compartments and More

— FREE ESTIMATES —

Clifton & Carryl Hebert, Owners

Bus.: (337) 630-9027 Home: (337) 598-4790

Pager: (337) 421-8382

GRAND LAKE GOSPEL JAM

Saturday, Sept. 22 -- 6:00-8:30 p.m.

FIREMAN'S CENTER - GRAND LAKE, LA.

— FREE ADMISSION —

- Hot Dogs & Cold Drinks Will Be Served

This will be a time to meet and greet old and new friends!

Sponsored By:

Grand Lake Community Church, a Southern Baptist Mission

Bible Study on Tuesdays at 6:30 pm in the Center (the book of Revelation)

For More Information Call: Bro. Mike Paris at 438-2313

TO CAMERON PARISH VOTERS RESIDING IN THE FEMA PARK IN GRAND LAKE:

I am sorry I was unable to personally go to your door and ask for your vote. I spoke with four different FEMA personnel to get permission to visit with you, but was told politicking of any sort was prohibited within the park.

Through this ad, I am asking for your vote and support.

Thank You,



PLEASE VOTE #63

Allyson Bourriaque

Cameron Parish Assessor

(Paid for by Allyson Bourriaque)

COME SEE THE ALL NEW 2008...



SUPER DUTY TRUCK

BUILT STRONG — BUILT TOUGH
BUILT BETTER
TO WORK HARDER FOR YOU!!



Great Line-up... Experience It Now!!!

* Must Finance With Ford Motor Credit - With Approved Credit - Limited Time Only



Tony Trahan
Sales Manager



Alice Guidry
Sales Representative



Joey Bourque
Sales Representative

Acadiana Ford



QualityCare at your service



418 E. First St. • Kaplan, La.

(337) 643-7124 — 1-800-738-2922

Dear Local Merchant,

Number 4 Reason why you should increase your advertising...

4. Your advertising is part of your sales force. Ads help to pre-sell the customer and help you close the sale faster. That saves you time and saves you money.



Call Jeffra DeViney, Advertising Sales Representative today to discuss your advertising...

786-8004 or 1-800-256-7323.

The Cameron Pilot

203 Harrison St. • P. O. Box 995 • DeQuincy, La. 70633

Mandatory meeting on Sept. 24 for 4-H Shooting Sports

Cameron Parish Shooting Sports will be hosting a mandatory meeting for all 4-H members wishing to participate in the shooting sports program this year. The meeting will be conducted at 6:30 p.m. Monday, Sept. 24, at Grand Lake School Cafeteria.

We will be scheduling training and practice dates along with fundraising ideas. Also, the club has guns available for anyone to shoot at practice or 4-H competitions. It is very important that you and your parents attend. Our program needs volunteers to assist with practice times, so that we can get things up and running in preparation for the State Competition.

To join the Cameron Parish Shooting Sports club youth must join a 4-H club at their local school each year. Youths must be between 9 and 18 years old as of January 1st of the current school year. Youth must join the club at their school or if a school does not have a club they can join the Cameron Member at Large Club.

The shooting sports club meets at least once a month from October thru May. The club days are usually on the weekend. At the end of the

year, a parish contest is held in April. 4-Hers can also show their skills at the State Shooting Sports competition in May and seniors can qualify for National competition. Youth will have access to firearms and bows that were purchased by the club to use for practice or competition in all disciplines.

Instructors teach safety lessons and 4-Hers are broken into four areas in which they would like to concentrate their skills. The five disciplines offered to youth in Cameron Parish are: Rifle (BB gun, Air Rifle), Archery, (recurve and compound), Shotgun, Muzzleloader and Hunting Skills.

The shooting sports program is run strictly by volunteer support. Instructors go through a certification process to teach youth on the parish level. We are always looking for volunteers to be instructors or assistants who can help teach. To be an instructor or assistant it requires at least one weekend a month of your time and you must love working with youth.

Four-H is open to all young people adhering to the aforementioned minimum requirements, regardless of race, religion, color, sex, national origin, or handicap.

If you need assistance in participating in any Cameron Parish 4-H event, please contact the Cameron 4-H Office located in Grand Lake. For more information on joining 4-H and the shooting sports program or becoming a volunteer please call 905-1318 or e-mail cameron@agcenter.lsu.edu.

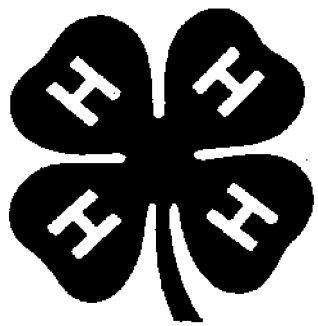

Tough week for Tarpons

By CHRIS & LAURIE MUELLER

After a big home opening win last week over the DeQuincy Tigers, the Tarpons had somewhat of a let down in their first road game of the season Thursday night at Vinton losing to the Lions 31-14. The Tarpons fell to 1-1 on the young season.

The Lions did most of their damage on the ground as they amassed nearly 400 yards rushing with their option running attack.

The Tarpons got on the board first with 6:49 remaining in the first quarter on a Kyle Little to Jaylon Ball 37 yard pass play to give them a 7-0 lead. The Lions answered with three straight touchdowns to take a 18-7 halftime lead. The Lions then put the game out of reach with a score

in the third quarter to up their lead to 25-7.

The Tarpons' Little to Ball combination was good for one more score in the 4th quarter on a 40 yard pass play. Little ended the night 11-19 for 159 yards. Ball caught 5 passes for 123 yards to give him his second straight 100 yard receiving game.

The Tarpons running game was nearly non-existent as they only managed 28 yards rushing. Last week against DeQuincy, South Cameron ran for 190 yards. The Lions scored once in the 4th quarter on a 64 yard run making the score 31-14.

Kirby Kingery had 7 rushes for 22 yards and 3 receptions for 5 yards. Jonathon Trahan added 8 yards rushing and Justin Trahan caught 2 passes for 28 yards.

Tarpons will face Kinder Yellowjackets on Friday

By CHRIS & LAURIE MUELLER

The 1-1 South Cameron Tarpons will be back home Friday night for a 7 p.m. match-up with another tough class 2A opponent in the Kinder Yellowjackets. The Jackets, also 1-1, beat Elton the first week of the season 57-18 and lost to a very tough Oakdale squad 34-14. The Jackets, district champions last year in district 5-2A with a 10-2 record, lost last year in the regional round of the playoff to Springhill 49-38.

The good news about facing Kinder is that All Southwest Louisiana Small Schools MVP Justin Reed has

graduated. Reed amassed 4600 yards passing in his 3 years as a starter. The bad news is that Jordan Allen, Reed's replacement, has done well throwing and running in his first two games. Allen has thrown for 218 yards and 3 touchdowns in his first two games. Even though the Jackets only return 3 starters from last year's powerhouse offense they seem to have reloaded well this season.

The bright spot so far this season for the Tarpons has been the passing of Kyle Little (14-30 268 yards and 3 TDs), the receiving of Jaylon Ball, 8 catches for 232 yards and 3 TDs, and the running of Kirby Kingery, 25 carries for 133 yards. The Tarpons hope to get back to the intensity level of their emotional week 1 victory over the DeQuincy Tigers after playing somewhat flat last week against the Vinton Lions.

Chris' Picks

By CHRIS MUELLER

Last week I went 13-3 for an early season record of 23-5 with a .821 winning percentage. This week I see:

- Oberlin over DeQuincy
- Many over Pickering
- East Beauregard over Merryville
- Oakdale over Ville Platte
- South Beau over Basile
- Kinder over South Cameron
- St. Louis over Vinton
- LSU over Middle Tennessee
- McNeese over ULL
- Cal over La Tech
- Texas A&M over ULM
- Southern over Prairie View
- Houston over Tulane
- New Orleans over Tampa Bay
- Dallas over Miami
- Houston over Carolina

8th Annual Atchafalaya Catfish Festival
September 29
Melville, LA
Call (337) 623-4226

Fall in love with Louisiana all over again.

LSU AgCenter program to be held on Sept. 20

Filling municipal landfills with horticulture waste and industrial bio-solids should not be an option in today's landfills. There are alternative methods of handling these waste products with current technology, according to Robert Turley, LSU AgCenter horticulturist, Lake Charles.

That is the topic of the upcoming educational program Thursday, Sept. 20, at the LSU AgCenter-Calcasieu Parish, 7101 Gulf Hwy, Lake Charles. Registration begins at 9:45 a.m. and the program at 10 a.m.

The topic is "Vision of A Southwest Louisiana Regional Bio-Solids Management Facility." Speaker is Geoff Russell, Senior Research Chemist with Sasol North America R&D in Westlake.

A facility of this type would handle horticultural

waste and both domestic and industrial bio-solids by converting them into a useable product. The product could be a compost material (made from bio-solids and wood waste) or dried bio-solids concentrate. Each product would be safe for use in gardens and agriculture soils.

The program is sponsored by the SWL Master Gardeners in the public interest. It is offered free of charge to all interested persons.

La Fete D'Ecologie
September 29
Thibodaux, LA
Call (985) 447-0868

Fall in love with Louisiana

Reliable
Month after month
Season after season
McKenzie Pest Control
THE HOME PROTECTORS
Call 478-7826
mckenziepestcontrol.com • Serving SW Louisiana since 1951

JOIN US...
FRIDAY, SEPTEMBER 14
~ Featuring Music By ~
"ABE MANUEL"

9 p.m. - 1 a.m. — Cover Charge - \$5 Per Person

THE ICE HOUSE BAR
408 Marshall St. • Cameron
Phone: 775-2967
Theresa Authement, Owner

POOL TOURNAMENT
Sat. Sept. 15 - 8 p.m.
\$5.00 Entry Fee

POKER MACHINES ARE ON!!!

~ FEATURING ~
• 3 Pool Tables • Big Screen TV
• Internet Jukebox

Hours: 10 a.m. Until -- Mon. - Sat. -- 1 p.m. Until -- Sun.

Coldest Beer in Town!!

— NOTICE —
Cameron Parish to hold Election October 20, 2007

If you are registered in Cameron Parish and have been displaced as a result of Hurricane Rita, you are still eligible to vote in your home parish (if you have not registered in another parish or state.)

There are (3) ways:

- 1) Absentee by mail ballot request
- 2) Early voting (which will be done the week before the election)
- 3) In person at the polling place on day of Election

For more information on how to check your current registration status, and find out what is needed for a ballot request, please contact the Registrar's Office @ 1-337-775-5943.

Election Day is October 20, 2007. It is very important that those who choose to vote by mail must send a written request for a ballot. This must be done in advance for time reasons and must be done starting now. Request will be stopped 4 days before the elections (requirements of State law.)

Our mailing address is:
Registrar of Voters Office
P. O. Box 1
Cameron, LA 70631

Thank you,
Suzanne Sturlese, Registrar

RUN: Aug. 23, 30, Sept. 6 & 13 (AU-46)

Southwest Homes

436-5593 or 1-800-256-8006

Why Buy Locally?

- Largest Housing retailer in SWLA
- Exclusive Trane A/C in all homes
- In House Service Department
- Over 200 models to choose from
- We handle SBA Loans
- We assist with Road Home Programs
- All homes exceed Cameron Parish Building Codes
- We have been in business over 20 years

500 S. M. L. King Hwy • Lake Charles, LA

Deer Valley
HOMEBUILDERS, INC

PLACE ORDER NOW!

Homecoming
Friday, October 5

It's time to celebrate and congratulations are in order...Reserve your space now for the special someone you want to remember in this year's Homecoming Edition. Ad costs start at \$44.50 (example shown below) and must be in our office and paid for not later than **Thursday, Sept. 27 at 5 p.m.**

Ad including picture, information and payment may be mailed to P. O. Box 995, DeQuincy, La. 70633. If you need further information call 1-800-256-7323 between the hours of 8 a.m. and 5 p.m.

Congratulations

Katelyn Reina
Senior
Homecoming
Maid

We Love You,
Dad, Mom,
Kathryn & Kristopher

CLASSIFIEDS

FOR SALE

METAL OUTLET Metal Roofing ~ Carports ~ Metal Buildings ~ Patio Cover Kits ~ C's & Z's ~ Custom Trim ~ RV & Equipment Covers ~ Metal Doors ~ Windows. 337-625-2778. 2241 E. Napoleon, Sulphur. Open Mon.-Fri. 7 am-5 pm, Sat. 7 am-12 noon. ttc.

DRIVEWAY MATERIAL, 14 yards delivered. Call for information: Falcon Dirt & Tractor Service, 526-9084 or 527-7155. 8/9-30p.

LIVING ESTATE Sale: 1001 Andrew Mouhot Rd. Ragley. For info and directions call (337) 304-0404. Sept. 14 - 30, 8 am to 6 p.m., please. Large collection of item including: Building materials, used tin, concrete culverts, framing lumber, pipe, angle iron, plate, equipment, gradall on tracks, winches, 2 tractors with many implements, sawmill and edger, 16' trailers, knuckle boom loader, tools for welding, woodworking, table saw, planer, hand tools. Something for every one. Lots of garage sale items. 9/12-9/26p.

PLUMBING

PLUMBING: Residential, commercial, new work, remodel & repair. bonded & insured. La. Lic. Master Plumber #4820. Call 743-6790. 8/29-9/26 eowp.

HELP WANTED

GROUND SUPPORT needed to assist in fueling and loading aircraft at Rotercraft Creole Base. Schedule is 7 & 7, 12 hour days. For more information call 775-5898. 9/5 - 9/17c/

HELP WANTED

HELP WANTED: Early mornings, off by 10 am. Earn while you learn donut making. Local family owned bakery is now hiring full time & part time help - fryer & cutter. No experience necessary. Great pay. Benefit options include housing, insurance, vacations, bonus pay & more. Must be conscientious, honest & stable individual. Apply in person at Delicious Donuts, 2283 Country Club Rd, Lake Charles. 9/5 & 9/12p.

SOUTH CAMERON Memorial Hospital Job Opening for Transportation Driver. Must be 21 years of age with clean driving record. Full Time Position with Benefits. Applications can be picked up at Calcasieu Oaks 2837 Ernest Street #A Lake Charles or fax resume to 439-1970 attention Human Resource Dept. 9/12c

SOUTH CAMERON Memorial Hospital Job Opening in Dietary Dept for Cook. Full Time Position with Benefits. Applications can be picked up at Calcasieu Oaks 2837 Ernest Street #A Lake Charles or fax resume to 439-1970 attention Human Resource Dept. 9/12c

SOUTH CAMERON Memorial Hospital Job Opening in Dietary Dept for Food Service Technician. Full Time Position with Benefits. Applications can be picked up at Calcasieu Oaks 2837 Ernest Street #A Lake Charles or fax resume to 439-1970 attention Human Resource Dept. 9/12c



Permit deadline set for shrimpers is Oct. 26

By KEVIN SAVOIE

All shrimp vessel owners are reminded that after Oct. 26, applications for commercial shrimp vessel moratorium permits (moratorium permit) will no longer be accepted or approved. Vessels fishing for or possessing shrimp in federal waters of the Gulf of Mexico have needed a moratorium permit since March 26, 2007.

NOAA's National Marine Fisheries Service (NOAA Fisheries Service) identified more than 2,600 vessels that might qualify for a moratorium permit. So far, just over 1,800 moratorium permits have been issued.

If you have obtained your moratorium permit, you do not need to do anything else. However, NOAA Fisheries Service would appreciate it if you would pass this bulletin along to other shrimp vessel owners who may be eligible for a moratorium permit, and let them know the application deadline is approaching.

Who is eligible?

NOAA Fisheries Service first required commercial shrimp vessel permits in December 2002. Vessels eligible for a moratorium permit must have been permitted before Dec. 6, 2003. The vessel is still eligible for a moratorium permit, even if it was sold to a new owner after Dec. 6, 2003.

In addition, an owner who sold his qualified vessel or otherwise lost use of his qualified vessel (i.e., damage, sinking, unaffordable repairs, repossession) may be eligible. If, prior to Sept. 26, 2006, the owner obtained a new vessel permit for the same vessel or a replacement vessel of at least 5 net tons that is equipped for offshore shrimp fishing, then the vessel is eligible for a moratorium permit.

NOAA Fisheries Service permit records are the sole basis for determining eligibility. A person who believes he/she meets the permit eligibility criteria based on ownership of a vessel under a different name, as may have occurred when ownership has changed from individual to corporate or vice versa, must document his/her continuity of ownership.

How to get a permit

If you are the owner of a shrimp vessel and you think your vessel qualifies for a moratorium permit, please contact the Permits Branch at the address listed below:

NOAA Fisheries Service Southeast Regional Office, Permits Branch, 263 13th Avenue South, St. Petersburg, Florida 33701, Phone: 727-824-5326, Fax: 727-551-5747.

Applications for a moratorium permit also are available on NOAA Fisheries Service's Southeast Regional Web site at <http://sero.nmfs.noaa.gov>. The application may be filled out online, printed, and mailed to the Permits Branch at the address above, along with all other pertinent information and payments.

A fee will be charged for each permit application or a written request for permits replacement. The applicable fee is specified on the appropriate form.

Incomplete applications

If an application is received that does not have all the necessary information, the Permits Branch will notify the applicant telling them what is needed to complete the application. The applicant then has 30 days to provide the needed information. After 30 days, the application is considered abandoned, and the applicant must submit a new application.

Notification of ineligibility

If the applicant does not meet the applicable eligibility requirements, the applicant will be notified in writing of such determination and the reasons for it.

Permit transferability

Commercial vessel moratorium permits for Gulf shrimp are fully transferable, with or without the sale of the vessel. The owner who is transferring the permit must sign on the reverse of the permit, and the signature must be notarized. The person who is to receive the transferred permit must ensure the transfer information on the reverse of the permit is complete and return the permit and a completed application for transfer to the Permits Branch.

Renewal

Renewal of a commercial vessel moratorium permit for Gulf shrimp is contingent upon compliance with the recordkeeping and reporting requirements. A commercial vessel moratorium permit for Gulf shrimp that is not renewed will be terminated and will not be reissued during the moratorium. A permit is considered to be not renewed when an application for renewal, as required, is not received within 1 year of the expiration date of the permit.

How can we improve these fishery bulletins?

If you have any suggestions on how we may improve future fishery bulletins please contact:

Kim Amendola, Communication Specialist, Phone: 727-551-5707, Fax: 727-824-5320, E-mail: SERO.Communications.Comments@noaa.gov

If you would like to receive these fishery bulletins via e-mail as soon as they are published, please e-mail us at the address below. You will still receive a hard copy of these bulletins through the mail.

E-mail: SERO.Communications.Comments@noaa.gov and include (1) "Request for Electronic Fishery Bulletins" in the subject line, and (2) your preferred e-mail address in the body of the e-mail.

This bulletin provides only a summary of the information regarding the existing regulations. Any discrepancies between this bulletin and the regulations as published in the Federal Register will be resolved in favor of the Federal Register.

Cameron Outdoors

By LOSTON MCEVERS



TEAL SEASON OPENS SATURDAY

The CCA's - S.T.A.R. - Tournament and Anglers Rodeo Statewide, has come to an end, for the 2007 year. Lucky Anglers taking first place will receive a Boat-rigged out and trailer in most cases.

In our area (West Division), the largest Speckle Trout will go to Larry Simon 7.25. Placing second was Dennis Laverne 7.20 and third was Daniel Pruitt 7.20. The largest in the east was 7.30 and central 7.50 pounds.

The Flounder (West Division) goes to Quentin LeBouf 5.05, second Jeff Sherill 4.90 and third David J. Ward 4.75. The east had a 5.20 for number 1.

The Sheephead statewide was Alan Thibodeaux 10 pounds and second Allen Bradbury 9.50 and third was Christopher Nalty 9.05.

The Lemonfish top angler was Justin Lane 73.82, second Dale Thibodeaux 53.5 and third Matthew Adams 46.10 again statewide.

Blackdrum largest was Johnathan Maestie 57.55, second Josh Chush, 49.0 and third Savannah Hayes 47.50, again statewide.

The Yellowfish Tuna statewide was Scott Pecue 223.25 pounds.

The Mangrove Snapper largest was Paul D. Frey 12.58, second Rodney Wagley 12.16, third was Larry Hafford 11.80.

Amberjack - John Tabor 92.95, taking second and third place was Beau Tate 90.80 and 87.60.

The top Louisiana duck caller is Jason Campbell of Iowa, his second year in a row. Awarded at the Gueydon Duck Festival.

The alligator season is in full swing and hunters are doing good, telling me there's more water in our marshes this year, letting them cover more ground.

It seems that the (mess-up) in the Deer Tagging system that the La. Wildlife and Fisheries Commission implemented has been suspended the staff mandatory tagging for 2007-08 hunting season.

TEAL HUNTING

This Saturday, Sept. 15, the special teal season opens for bluewinged, green winged and cinnamon teals, as well as yellowbills and rails. The teal limit is 4 daily and possession of 8. Hunting hours are 1/2 hour before sunrise to sunset. The season runs through Sept. 30.

Gallinules and Rails runs the same date, shooting hours the same times. Gallinules bag limit is 15 daily and 30 possession. King and Clapper limit is 15 in aggregate, and Sora and Virginia limit is 25 in aggregate. Possession 30/25.

There are changes for youth hunting this year, as the La. Dept. of Wildlife and

Fisheries reminds all hunters; 11 years old and younger, must be accompanied by an adult who is at least 18 years old and have a valid hunting license and must be hunter education certified. The adult has to be within talking distance and have the youngster in site at all times. Remember only youth 10 years old or older can be hunter education certified.

If a youth is 12 to 15 years old and has passed the hunters education certification, they can hunt unsupervised. Remember, 10 and 11 year olds still need supervision even though they have been hunter education certified.

We really need to start the cool weather, which would help not only teal season, but for our next dove split, Oct. 13-Nov. 25.

"D" BEND

Several of our local anglers entered and fished the Oilmens' Classic at Toledo Bend's Cypress Bend. Darren Thibodeaux and Danny Demary placed 50th on the first day and 22nd on the second day to come out 27th place overall.

There were 300 boats entered. Travis and Kirk Broussard placed 4th on the second day and come out 18th place overall. These anglers were money winners. Jeff Tall of our neighboring parish had a 10.98 largest bass. There were several 6 to 8 pounders caught. A Texas angler had 23 pounds on day one and 14 on day two to have a 37 pound overall first place winners. Second place winner overall had 29 pounds.

All locals say it was tough fishing and very hot. They used spinner-baits, large worm fished Texas style, Carolina rigs with plastic lizards, but both of these teams tell me jigging was slow, but did produce especially on points in 18 feet of water.

AREA FISHING

Good reports of Redfish on Big Lake, but trout fishing is still holding on, especially on the northern part of the lake to include Prien Lake.

This is the time of the year where you can say here in southwest Louisiana, "Good Fishing and Good Hunting!"

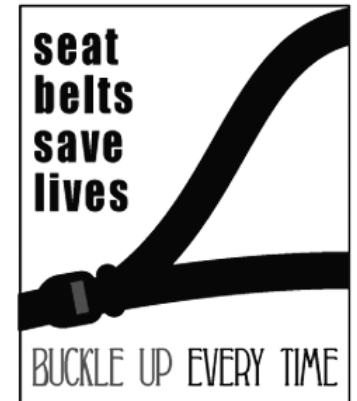

FOR SALE IN SWEETLAKE



Two-story, 1932 living, 3388 total, 3 bedroom, 2 bath, wood floors & ceilings, granite, built-in shower, completely remodeled in 2004. 1 acre. Please call: 540-9561

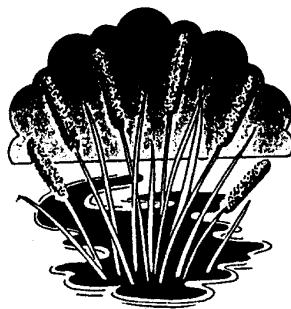

Let Us Build This Home For You...



1650 Square Feet Exterior Shell Built On Your Lot For... \$79,900.00

Architect plans provided. Concrete siding, soffit, & fascia; 30 year architect shingles; 10"x10" pilings set to your elevation; 9' ceilings; Engineered truss systems; Custom deck with stairs; 2x4 Exterior walls built to hurricane code.

Pintail Construction & Development, INC

337-491-1984

Porch and concrete slab-extra charge.

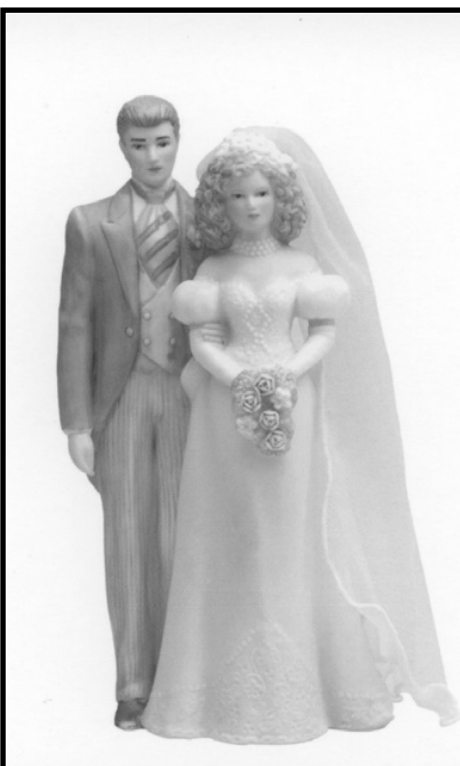

ATTENTION BRIDES...

Let us help you select your perfect... Wedding Invitations and Accessories. Choose from 100's of designs, and express yourself with style and elegance on your day. View our collection of elegant wedding invitations online at: www.bestwiseideas.com or call today to arrange for an appointment.



WISE IDEAS

Call Jeffra DeViney at 912-5063

LRA tours Cameron Parish to view recovery efforts

By JEREMY HARPER
(American Press)

Board members and staff of the Louisiana Recovery Authority toured Cameron Parish by bus Tuesday to get an up-close look at how the parish's coastal communities have recovered from Hurricane Rita over the past two years.

The LRA officials toured South Cameron Memorial Hospital, which, as the first public building to be rebuilt in Cameron after Rita, is set to become a monument to recovery when it opens in late October or early November.

"It just shows the resilience of the people," LRA Chairman Norman Francis said after touring the hospital. "I mean it's unbelievable. To be hit as hard as this parish has been hit... this is just amazing."

The new \$22 million hospital - elevated and wind-resistant - is being built with a combination of federal and state money. Cameron Parish voters overwhelmingly approved a property tax increase last year to help with the operating expenses of the 20-bed facility.

The afternoon bus tour also passed through Grand Lake, Cameron, Creole, Holly Beach and Hackberry, offering glimpses of rebuilding and lingering storm damage.

Ernie Broussard, executive director of the Cameron Parish Office of Economic Development and narrator of the bus tour, said it was an opportunity to impress upon board members how much progress has been made in Cameron.

"It's a rare opportunity to showcase your plans and your mission for your community when you have the decision

makers from Baton Rouge," Broussard said. "What we're hoping to do is keep our plan, our projects and the public's concerns on the agenda of the LRA."

The reaction was overwhelmingly positive, he said.

"It's been very, very encouraging because they see we're doing things to help ourselves," he said. "They see that we're in a proactive position."

Before the tour, the LRA board met at the Lake Charles Civic Center and approved the long-term recovery plans for several parishes, including Calcasieu, Cameron and Beauregard.

The money is part of \$200 million in federal money for LRA set aside for long-term community recovery and distributed using a formula based on storm damage. The majority of the money has been dedicated to New Orleans, but Calcasieu will get \$5.6 million, Cameron will get \$8.5 million and Beauregard will get \$178,000.

The long-term plans were developed after numerous rounds of public input and planning.

Cameron Parish's top project was Cameron Square, a central governmental plaza that would include a refurbished courthouse, a parish administration office, district attorney's office, judicial center and correctional facility.

Calcasieu's top-rated project as presented to the LRA was the Southwest Louisiana Entrepreneurial Center. However, other projects, such as the Louisiana Wetlands Discovery Center or downtown Lake Charles development, could receive some of Calcasieu's cut.

The final breakdown of the funding will take place.

Hospital opening delayed

By CYNDI SELLERS

Opening of the South Cameron Memorial Hospital, earlier planned for the second anniversary of Hurricane Rita, has been delayed until late October or early November, according to Greg Fawvor, hospital board member.

Construction delays have delayed the opening of the hospital, even though most of the work has been done, Fawvor said. Contractors are waiting for the delivery of the outside canopies and safety rails, but all the interior furnishings and equipment have been delivered.

One delay was caused by the need to replace all the flooring, due to inferior work, but the new floors are now in place. The radiology suite is installed and the laboratory equipment is ready to go in. Some work remains on finishing the rooms and offices, but the administrative staff is expected to move into the hospital in 2-3 weeks and to begin staff training soon thereafter.

All staff will have to be re-trained before the hospital opens, because operations will be "paperless." All patient records, medications, orders, etc. will be kept on hand held computers and stored electronically.

Some of the delay has been beneficial, since it is the result of change orders approved by FEMA that allow upgrades to the original design. For example, the first plan called for a generator that would operate the emergency equipment and lights only, but because the radiology and other electronic equipment is sensitive to moisture, a larger generator was approved that will operate the entire facility, including air conditioners, in case of power outages. The cost will be covered by FEMA.

"If FEMA will pay for it, we're going to jump on it," said Fawvor. "We don't know when we could afford it otherwise."

Lunch menus

Cameron Parish school lunch menus for the coming week are as follows:

Friday, Sept. 7 - Beef Nachos, salsa, pinto beans, fresh vegetable, cinnamon rolls, tortilla chips, salad dressing, milk

Monday, Sept. 10 - Chicken alfredo, tossed salad, orange wedges, salad dressing, wheat biscuits, milk

Tuesday, Sept. 11 - Meatballs, brown gravy, rice, carrots, fruit salad, peanut butter spread, wheat rolls, milk

Wednesday, Sept. 12 - Chicken fried steak, mashed potatoes, fresh fruit cup, yellow cake, chocolate glaze, sliced bread, brown gravy, milk

Thursday, Sept 13 - Oven fried chicken, seasoned rice, blackeyed peas, fruit cocktail, wheat biscuits, milk

Arrest report

The Cameron Parish arrest report the past two weeks is as follows:

Aug. 31, Waylen Jude Lantier, 1135 Castille Dr. Church Point, D.W.I.

Scott Anthony Severson, 650 Oak Grove Hwy, Creole, Domestic Abuse Battery, Bench Warrant.

Gwin Michael Montou, 2415 La. Hwy. 93, Carencro, Destroy Legal Crab Traps.

James Ray Hebert, 416 Mermentau Rd., Youngsville, Destroy Legal Crab Traps.

Eric James Melton, 148 Main St. Hackberry, Six (6) Bench Warrants.

Frank David Pickett, 2211 Patton St. Lot E4, Sulphur, Bench Warrant.

Sept. 2, Joshua Elais Leger, 1504 Diane Dr. Sulphur, Bench Warrant;

Martin Matthew Perkins, 10 Rue DeVerge, New Iberia, D.W.I.

Sept. 3, Kathleen S. Dyson, 213 Veejay St. Cameron, Careless Operation.

Renee Bailey, 3703 Lake Breeze, Lake Charles, D.W.I.,

Driving under Suspension.

Sept. 6, Steven Jess Fahlenkamp, 207 Hebert Trailer Park #26 Lake Charles, Possession of CDS II (3 counts).

Walter Jolivett III, 10006 Pasquire St. Gueydan, Possession of Marijuana, Possession of CDC III, Possession of Drug Paraphernalia.

Jason Paul Nero, 3327 Carver Road, Lake Charles, Possession of CDS II (2 counts), Possession of Marijuana.

Sept. 9, Daniel Carl East, 108 Lake Breeze Rd. Hackberry, Public Intoxication, Resisting an Officer;

Sept. 10, Jerry L. Richard Jr., 13555 Arnold Rd. Walker, D.W.I., Speeding, Careless Operation.

Nicolas Trejo, 10423 Herald Circle, Northport Ala., Speeding, No D. L.

Ryan Taylor, 312 1/2 Mercury Rd. Morgan City, Possession of Marijuana, Possession of Drug Paraphernalia.

Break-in is investigated

On Sept. 4 Calcasieu Parish Sheriff's Office was dispatched to a home on Big Lake Road in Lake Charles regarding a homeowner finding an intruder in his home.

Investigation revealed the homeowner returned to his home around 9:30 a.m. and saw a pickup truck in his driveway. He noticed the glass broken on his door. He went inside and yelled for the intruder to come out, then went outside and called 911.

The intruder walked out of the house, got into his truck and drove off. The homeowner was able to get the license plate number as the intruder drove off.

When deputies arrived, they entered the license number into the national data bank and while patrolling in Moss Bluff, a deputy spotted the truck and pulled it over on Highway 171. Robert Paul Bacon, 26, 425 N. Pine Dr., Ragley, was taken to the Sheriff's Office where he was interviewed by detectives.

Bacon was booked into Calcasieu Correctional Center and charged with unauthorized entry of an inhabited dwelling and criminal property damage.

Bacon's bond was set at \$25,000 by Judge Rick Bryant. He is currently on probation until 2010 for a burglary and theft conviction in 2007.

CPSO Det. Christopher Cormier is lead investigator on this case.

Drug bust in Klondike

The Cameron Parish Sheriff's Office, in cooperation with the Vermilion Parish Sheriff's Office, conducted a drug bust in the Klondike area last Thursday, Sept. 6, resulting in the arrest of Walter Jolwette III, 35, at his residence, 131 Dixie Drive, Klondike.

At the time of his arrest, Jolwette was in possession of 801 Lareet and 50 Ecstasy pills and half a pound of marijuana. He was charged with possession of controlled dangerous substance Schedule III with intent to distribute, possession of marijuana, and possession of drug paraphernalia.

Also on Sept. 6, Stephen Jess Fahlenkamp, 207 Hebert Trailer Park Lot 29, Grand Lake, was arrested on three counts of distributing CDS Sch. III. Fahlenkamp was on the list of subjects in the drug sweep conducted by the Sheriff's office. He was apprehended when he showed up for a court date.



Road Home meetings set

A series of Information Sessions on The Road Home Homeowner program will be held in Southwest Louisiana throughout the month of September. Information Sessions will provide homeowners the chance to ask questions about program eligibility, application status, required documentation, and

more. Rental property owners who applied in Rounds 1 or 2 and have questions are encouraged to attend the information sessions at Lake Charles Central School. These sessions are free and open to the public.

Wednesday, Sept. 12, 2007, Lake Charles Central School, 809 Kirby Street Lake Charles, Calcasieu Parish, 6-8 p.m.

Wednesday, Sept. 19, Lake Charles Central School, 809 Kirby Street, Lake Charles, Calcasieu Parish, 6-8 p.m.

Wednesday, Sept. 26, Lake Charles Central School, 809 Kirby Street, Lake Charles, Calcasieu Parish, 6-8 p.m.

Friday, Sept. 28, Johnson Bayou High School, 6304 Gulf Beach Highway, Johnson Bayou, Cameron Parish, 6-8 p.m.

For more information on The Road Home program, visit www.Road2LA.org or call 1-888-ROAD-2-LA (1-888-762-3252). TTY callers use 711 relay or 800-846-5277.

Great Southern RV Bluegrass Event
September 20-22
Angie, LA
Call (225) 241-0125

Fall in love with Louisiana all over again.

LOUISIANA
OFFICE OF THE LT. GOVERNOR
Department of Culture, Recreation & Tourism
LouisianaTravel.com

REGISTRATION DEADLINE FOR October 20, 2007 ELECTION

In order to vote in the October 20, 2007 election you must be registered by September 19, 2007. You can REGISTER by mail (by requesting a form) or you can come to our office located in Cameron behind the courthouse, first trailer to the right. Our phone number is (337) 775-5493.

Thank you,
Suzanne Sturesse, Registrar

RUN: Sept. 13 (S-11)

To the Voters of Cameron Parish:

Now that I have completed my door-to-door campaign within Cameron Parish, I would like to thank each of you for being so kind. I know it was virtually impossible to find everyone at home. If you were out at the time of my visit, I hope you found the "Sorry I missed you" note attached to my campaign brochure when you returned. To the many who took the time to call my home after they found my note, I thank you for being so considerate.

To reiterate some of my experience and qualifications, I have...

- ★ 24+ years in the Cameron Parish Assessors Office having worked in ALL fields of the assessment process
- ★ 19+ years of IAAO (International Association of Assessing Officers) schooling
- ★ 15+ years designation as a Certified Louisiana Deputy Assessor
- ★ 15+ years as an IAAO member
- ★ 25+ years of Parishwide Community involvement in many areas

On October 20, 2007, please vote for the experience, knowledge, dedication and qualified leadership I have exhibited throughout the parish. If you have any questions for me, I may be reached at (337) 542-4264.

PLEASE VOTE #63
Allyson Bourriaque
Cameron Parish Assessor
(Paid for by Allyson Bourriaque)

Grand Opening Thursday, September 27, 2007 10:00 a.m. - 4:00 p.m.

CAMERON PARISH WATER AND WASTEWATER DISTRICT ONE

126 Ann Street

Door Prizes To Be Given Away Throughout The Day

Register For Prizes At Our New Office When Paying Your Bill Now Until Grand Opening

ONE PRIZE PER PERSON
Need Not Be Present To Win

BOARD MEETING -- 5:30 P.M.

CAMERON PARISH RESIDENTIAL PICK-UP ROUTE

- Monday: Hackberry
- Tuesday: Klondike, Little Chenier, everything West of Hwy. 27 in Creole, which includes W. Creole Hwy. and Trosclair Road, through Cameron to the Ship Channel.
- Wednesday: Grand Lake, Hwy. 384 East of Intracoastal Canal through Grand Lake to Fournerat Road, North to the Parish Line and East to Hwy. 27, which includes LeBoeuf Road.
- Thursday: All of Big Lake and Hwy. 385 from Boone's Corner North to the Parish Line, which includes Parish Line Road.
- Friday: Sweetlake Area, Hwy. 27 and East of Hwy. 27, Sweetlake Camp Road, Hwy. 384 from Fournerat Road South and East to Hwy. 27, East Creole, Oak Grove, which includes Warren Miller Subdivision, Grand Chenier and Chenier Perdue.

Any Questions, Please Call:
337-436-7229

WMM
WASTE MANAGEMENT

Just Kidding



What a Pest!

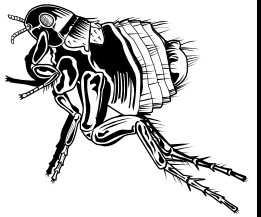

They are only 1/16 to 1/8 inches long when full grown, but even at that size, fleas cause a lot of problems. They don't just bug cats and dogs; they can cause humans medical problems, too, like allergies and tapeworms.



The dark reddish-brown insects are almost flat from side to side, so they can move through hair, fur and feathers pretty easily. Fleas don't have wings; however, they have three pairs of legs, and the back legs are longer, which helps them jump. They can leap up to 7 inches vertically and 13 inches horizontally, which is pretty far considering their size.



The mouths of fleas have piercing, sucking parts, and there are spines on their bodies that point backward, along with a row of spines on their faces called a genal comb.



Adult fleas cannot live or lay eggs without a meal of blood. Once they have that meal, they can live off of it for awhile. A female flea can lay 15 to 20 eggs a day after a blood meal, and she can lay up to 600 eggs during her life.

FIND THE TWINS

WHICH TWO ARE EXACTLY ALIKE?

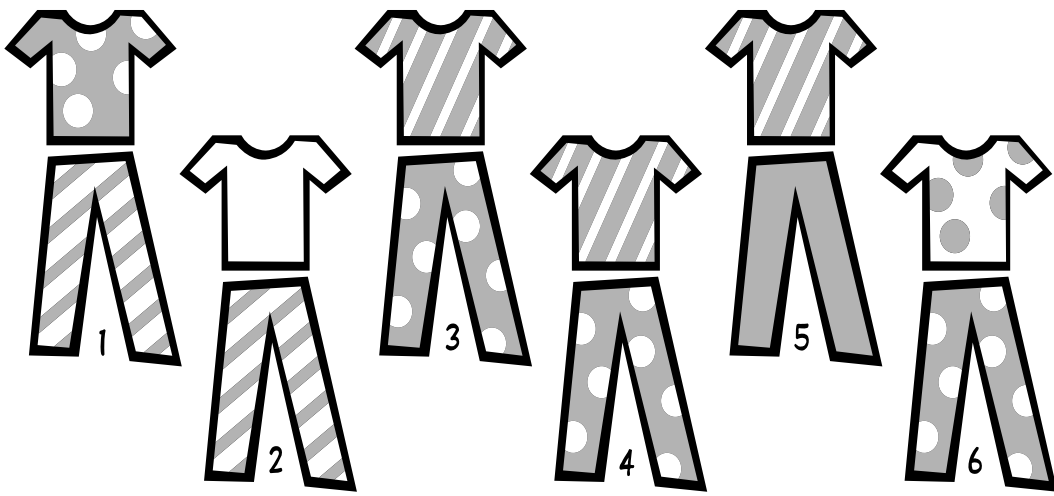

ANSWER: THREE AND FOUR

TIC

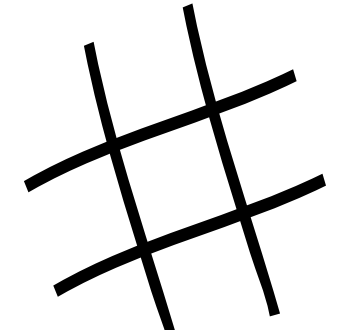

TAC

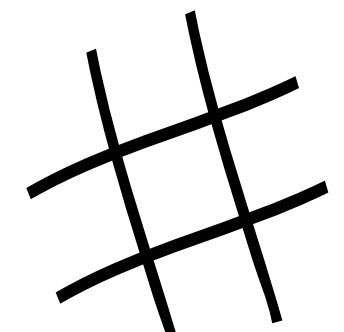

TOE

SEEK AND FIND

FIND THESE WORDS IN THE PUZZLE BELOW.

- | | | |
|---------|---------|------------|
| CHEER | JOLLITY | PLEASURE |
| DELIGHT | JOY | RECREATION |
| FUN | MIRTH | SPORT |
| GLEE | PLAY | ZEST |

THE WORDS READ UP, DOWN AND ACROSS.

D E L I G P L A Y T
 G L E J O L L I T Y
 Q D R E E W T Y P
 R E C R E A T I O N
 E L O I L S P O R T
 E I U Y G U T R D S
 H G W M I R T H S J
 C H F G Z E S T D O
 H T J F U N K M L Y
 B C A S V X A E V N

connect the dots

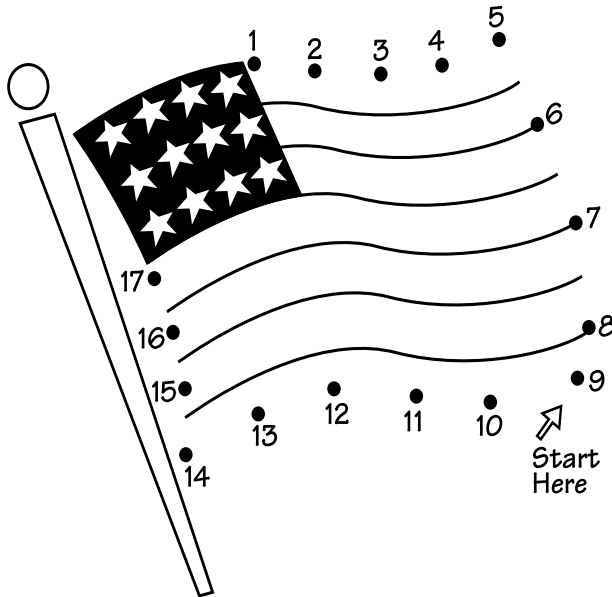

Horsing Around Safely



Horseback riding is a lot of fun. But before you gallop off, take a look at these guidelines to help make your ride safe and more enjoyable.

Before you start...

- Put on a safety helmet or hard hat.
- Wear sensible boots, like hiking or riding boots.

Check the horse...

- Make sure the horse's chin strap is done up right.
- Keep the reins in good order.
- Adjust stirrup leathers to be the right height for you.

Around the horse...

- Don't get too close to the horse's back legs. If you must, talk to the horse so it knows you are there.
- Mount and dismount from the right side.

During the ride...

- Enjoy your ride and don't ride too fast.
- Don't let your horse get too close to the one in front of you.
- Keep your feet in the stirrups and your heels down.
- Make sure you or your horse do not get too hot or cold.

In case you fall...

- If you feel like you're falling, don't stiffen up.
- Don't use your hands to break your fall.
- Curl in a ball when you hit the ground, then roll away from the horse.

If you have any questions or concerns, talk to the people where you're riding.

SECRET CODE

Why did the teacher have crossed eyes?

12 1 24 22 8 14 5 23 7 8 13
 22 8 7 13 11 8 5 1 24 11 9 14 9 2 5 12

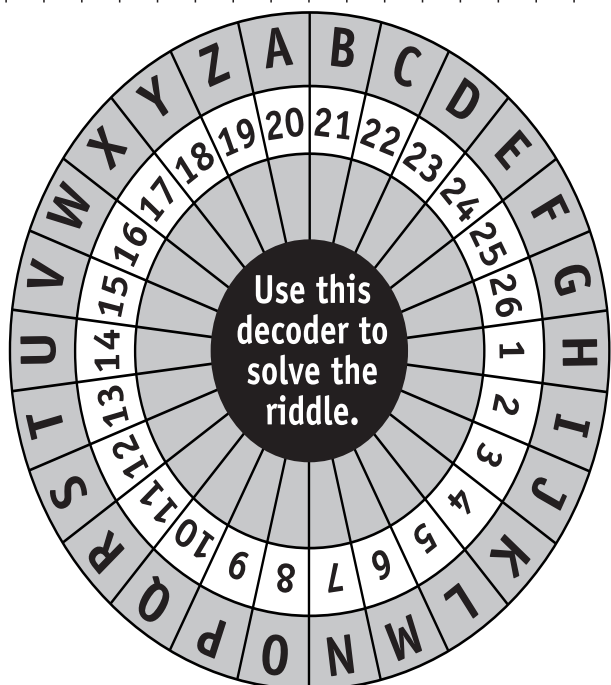

HIDDEN PICTURE

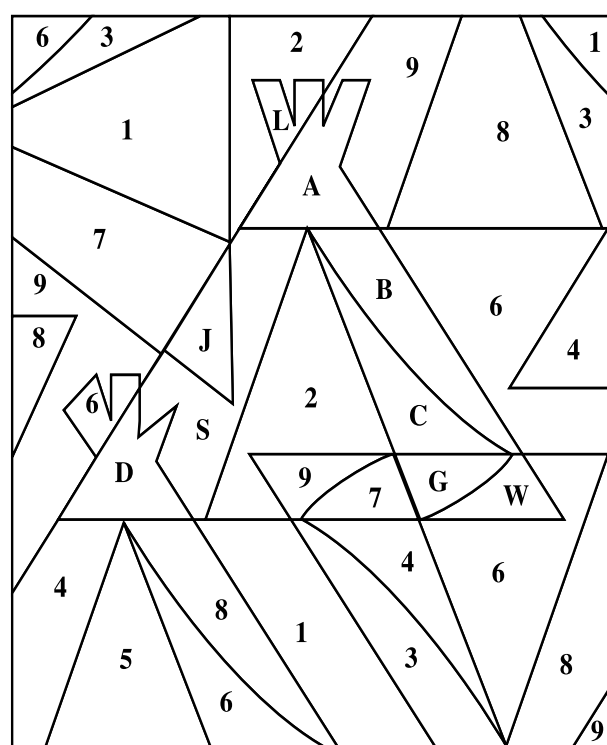

Color in each space that contains a letter.

Answers

N A V X S V B
 C A S A V S B
 L F U N H
 T M K M H
 D L S Z C
 O D L S Z C
 J H L R W H
 I L I O I E
 U L Y I I E
 R T D S E
 T L S P O R T
 R E C R E A T I O N
 O I O I A T I O N
 D R E W T Y P
 Q D R E E W T Y P
 G L E J O L L I T Y
 D E L I G P L A Y T

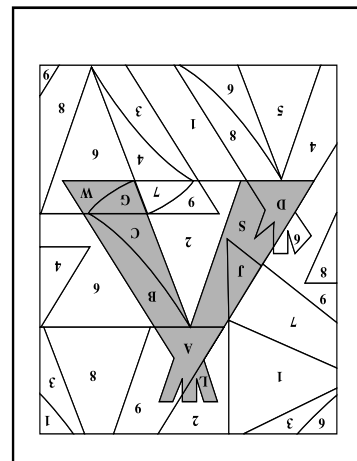
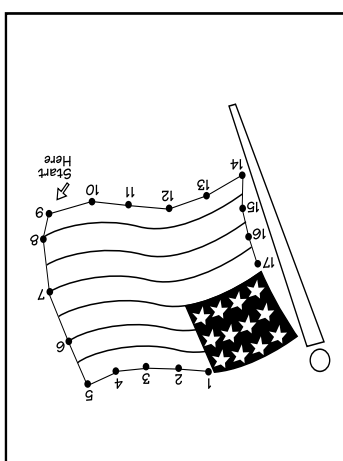



MRS. JUANITA SANDIFER is shown with several MDA donors. These students donated in the recent MDA drive and proceeds were then presented to the telethon in the name of Johnson Bayou High School.



PARENTS AND students visit Mrs. Leslie Landry's 4th grade classroom during the recent open house held on the Johnson Bayou High School campus.

It Seems Just Like Yesterday

By Keith Hambrick



Cameron Pilot Sept. 5, 1974 LITTLE CHENIER PARK PLANNED

Calcasieu and Cameron parishes each will get a new state preservation area under the provisions of the 15-year capital improvement plan approved by the 1974 Legislature for the Louisiana State Parks and Recreation Commission.

The Calcasieu facility will be the Beckwith-Hickory State Preservation Area, presumably to be located at the conjunction of these two creeks near the present Holbrook Parish Park east of Perkins.

The Cameron facility would be the Little Chenier State Preservation Area northeast of the town of Creole.

A new state park is also slated for the Chenier Au Tigre area in Vermilion Parish between Chenier and Pecan Island.

State Preservation Areas will be established primarily to preserve unique natural features. To insure the continued tranquility and protection of these areas, only such things as interpretive centers, nature trails, and similar facilities for the use of visitors will be provided.

This probably means that no elaborate facilities such as pavilions, cabins and docks will be erected at the Beckwith-Hickory and Little Chenier sites.

The Beckwith-Hickory area is thickly wooded and these streams presently have little development along their banks.

The Little Chenier area is noted for its beautiful marshes, old oak trees and a wide variety of bird and animal life.

The 15-year parks program will be financed through the issuance of revenue bonds to be retired through fees charged users of facilities at the state parks.

GALVESTON TRIP

The girls V. I. P. ball team of Cameron spent a weekend in Galveston to end their season with a bang. Included were Toni Cheramie, Darilyn Doxey, Patty Belanger, Pam Griffin, Jill Willis, Theresa Cheramie, Charlotte LaBove, Donna LaBove, Yvonne Mhire, Claudette Boudin, and accompanying the girls was Marty LaBove.

FIRST WEIGHTED VOTES ARE CAST

The first split vote under the Cameron Parish Police Jury's new weighted vote plan came at the jury's Tuesday meeting and one juror declared that he would not continue to serve if the plan remains in effect.

Shortly after the opening of the meeting, Ward 2 Juror Lyle N. (Butch) Crain made a motion that Jurors Charles Riggs and Norman McCall ask the federal court to either remove the weighted vote plan or call elections immediately.

(Riggs and McCall were the plaintiffs in a recent suit asking for reapportionment of the jury and for a weighted vote until new elections can be held. Judge Edwin Hunter ruled in their favor but indicated he did not intend to call an election before the regular elections in the fall of 1975)

Crain said he would not continue to serve under a weighted vote plan as two members of the jury could control the jury, but he did not say definitely that he would resign.

Juror Charles Precht of Sweetlake seconded Crain's motion, saying he wasn't in

favor of immediate elections but that the weighted vote needed to be clarified.

Police Jury President Ernest Myers also indicated that he was not in favor of quick elections. Under a reapportionment recently agreed upon by all six jurors, his ward, Ward 1, will be split in two and combined with Wards 2 and 4.

Myers said this probably will make it hard or impossible for him to be reelected since there are only about 250 people in his area.

When the vote came, it was 4 to 2 in favor of the motion by popular vote. But under the weighted vote, the result was 55.38 votes against the motion and 44.62 votes for, thereby killing the resolution. (Riggs and McCall cast the opposition votes.)

There the matter rested as the jury went on to other business, but the question of possible resignations remained.

A humorous incident reflecting this occurred at the end of the meeting. Juror Riggs traditionally makes the motion at the end of each meeting to adjourn. Tuesday, it came out as follows: "I'd like to offer a motion to retire -- uh, I mean to adjourn."

JURY ACCORD REACHED ON LIBRARY

The Cameron Parish Police Jury, Tuesday resolved an old bone of contention.

In October, 1972, the jury deadlocked 3 to 3 on the reappointment of Mrs. Charles Hebert to the parish library board. Jurors Charles Precht, Lyle Crain and Archie Berwick voted for Mrs. Hebert and Jurors Norman McCall, Charles Riggs and Ernest Myers voted for Mrs. Roberta Rogers of Cameron.

The jurors voting for Mrs. Rogers said they thought Mrs. Hebert had done a good job, but they were supporting Mrs. Rogers because they felt Ward 3 deserved a member on the board.

Since the jury was unable to reach an agreement, Mrs. Hebert has continued to serve on the board.

In the last session of the legislature, a bill was passed allowing library boards to increase their membership to seven.

At Tuesday's meeting, Juror Crain said that in the light of this new bill, he offered a resolution that two new members be named to the Cameron Library Board and that Ward 3 McCall be permitted to name the two members.

The rest of the jury agreed to this, and McCall then named Mrs. Ward Fontenot and Mrs. Floyd Baccigalopi as new board members.

Following this, Crain then moved, and it was seconded by McCall, that Mrs. Hebert be appointed to the term that she is presently serving without appointment. All jurors voted for the appointment.

Mrs. Broussard, parish librarian, was present at the meeting and thanked the board for appointing the two new members and also for reappointing Mrs. Hebert.

Other library board members are Mrs. Charles Precht, Mrs. Emma Nunez, C. J. Reina and Mrs. Helen Colligan.

BOYS VILLAGE SAYS THANKS

Recently the boys of Boys Village near Iowa were guests of the Doxy-Vincent VFW auxiliary and many families in lower Cameron Parish. Acting director of the Village, Elizabeth Leatherman, sent a letter expressing the appreciation of the boys village offi-

Winterize lawn with potash not nitrogen

To winterize Southern, warm-season lawns, apply a fertilizer with more potash than nitrogen. Potash is represented by the third number on a fertilizer bag, while nitrogen is shown as the first.

In the fall, the emphasis in feeding changes from growth to strength. In September, apply a fertilizer with less nitrogen to slow growth and more potash to build stress tolerance.

"Our lawn grasses are the warm-season type, so they grow when it's warm and not much when it's cool. That means we must encourage growth with nitrogen in warm weather and not push the grasses when we shouldn't," said LSU AgCenter horticulturist Dr. Tom Koske.

"The 'shouldn't' time is fast approaching," the horticulturist said.

A general, complete lawn fertilizer has three major nutrients listed in this order: nitrogen (N), phosphate (P2O5) and potash (K2O).

"If we keep feeding a relatively high N in the fall, we will spur soft, lush growth," Koske said, explaining that soft growth is more subject to diseases like brown patch. This damage won't have time to grow out of it because the cooler weather and shorter days won't let it.

"Our fall lawn care plan should encourage only moderate, slow growth on centipede and St. Augustine lawns," Koske said.

Beware of northern-blend winterize's that have high N and moderate potash. Apply any fall fertilization in September. It is not needed any longer in October.

Carials

The boys spoke highly of everyone in the parish and specifically thanked Louis Canik, Trans Ocean Oil Co., Crain Brothers, Lynn Jones, Louisiana Menhaden Co., Mr. and Mrs. Sam Mier, F. O. Theriot, Zapata Hainie, Dot Bourgeois, the VFW, VFW Auxiliary and the many families who took the boys.

CARIBBEAN CRUISE

Gail and T-Bolo Trosclair, Charlotte and Philip Trosclair enjoyed a Caribbean cruise aboard the MS Starward last month. Also on a cruise were Eldie and Tony Cheramie, and Mr. and Mrs. Hilaire Hebert aboard the MS Skyward, both Norwegian liners. They all enjoyed the voyage and said the food was fantastic.

Returning home, the Cheramies and Herberts visited Hugh and Rosalind Baker in Livingston, Ala. This was just after Alan's wedding, and Rosalind's were quite happy over finally having a "daughter." Alan and his new bride honeymooned in Florida, and are now living on campus at Tulane.

ROUNDBOUT THE PARISH

Mr. and Mrs. Walter Helms, Kathy Stone and Hardy Stone travelled to West Point this past week to see George Stone while he is off from his training. George had a four-day break between his basic training and classes.

Last Monday afternoon Mrs. Taylor was visited by her daughter and son-in-law, Mr. and Mrs. Ben Smith of Jennings.

Mrs. Lora Pennington and Mrs. Eddie Mae Fluk, and Kay and Edie travelled to Port Saint Joe, Fla., to attend a wedding of the family.

The Grand Lake Minor Girls team celebrated their winning season with a wiener roast at Rutherford Beach. Their coach Carolyn Gibbs presented each girl with the first place trophy from the

If you already have been applying about half as much potash as N, winterizing is not necessary. If you have been putting out mostly N this summer, apply a southern winterizer now or just muriate of potash (0-0-60) at 1 to 2 pounds of muriate per 1,000 square feet.

"If in doubt, it is better to do nothing at all than do the wrong fertilizer program at this time," Koske said.

Another important fall chore is to clear leaves from the turf surface to avoid blockage of sunlight. Also, maintain adequate moisture during this typically dry season to sustain slow but solid growth. In addition, raise the cutting height a notch except with centipede grass to get more leaf area for more stored food. One chore you don't have to do, however, is aerify or dethatch this late in the year.

If pests show up, get on them. Damage from disease or insects will hurt the turf's ability to store food for winter survival. Many times we are tempted to say, "Oh well, it's going to turn brown soon anyway."

If the diseased areas die and brown out this fall, however, expect the dead areas to still be dead next spring. Allow grass to go dormant in a healthy state for a healthy spring greenup.

For related landscape and gardening information, click on the Lawn and Garden link at the LSU AgCenter Web site, www.lsuagcenter.com. Also, contact the county agent in your local parish LSU AgCenter office.

Sheriff's league. Other persons attending were Mrs. Janice Crador, Mrs. Verna Mae Pettefier, and Sylvia Crador and Mr. and Mrs. Edwin L. Gibbs.

Cheryl Schexnider, member of the Hackberry Future Homemakers of America, attended the national convention in Chicago, Ill. Cheryl is the daughter of Mr. and Mrs. Alton Schexnider.

Mr. and Mrs. Huey (T-Boy) Theriot celebrated their daughter Becky's recent birthday with a birthday party. Becky's relatives, including her grandmother, helped her enjoy her day.

Mr. and Mrs. Whitney Miller and daughter of Lake Charles spent Sunday with the Roy Clarks.

Spending the weekend with Mr. and Mrs. Whitney Baccigalopi and family were Mr. and Mrs. Bobby Baccigalopi and family.



Submissions to the Cameron Parish Pilot

Engagement and wedding photos should be submitted to the Cameron Parish Pilot by 4 p.m. Tuesday.

Photos should be clear prints, head and shoulder pose, preferably 5x7.

Announcements and pictures are published free of charge.

Engagement and wedding forms are available to be picked up at the Cameron Parish Pilot office, located at 203 E. Harrison St., DeQuincy between 8 a.m.

THE SAVVY SENIOR

By JIM MILLER



Dear Savvy Senior

Can you offer some tips on protecting seniors from financial scams? My next door neighbor's elderly parents were recently swindled out of several thousand dollars and I want to make sure my own mother is protected. Fraud Fighting Cindy

Dear Cindy

Senior financial scams are a big problem! In fact, the Securities and Exchange Commission estimates that some 5 million senior citizens are the targets of financial abuse each year. Here's what you should know.

Appealing Targets

While people of all ages can be fleeced, senior citizens are particularly appealing targets to con artists. Why? Money, time and good manners! Seniors tend to have more money to steal, more free time to listen to sales pitches, are less likely to hang up on or cut off a pushy salesman, and are more trusting than the younger generations.

Scammers

It's not always easy spotting a con. They range from swindlers, to shady financial advisers to slick-talking telemarketers to professional caregivers and relatives who steal from the very people they're supposed to be looking after.

The most common scams targeting seniors today come in the form of free-lunch seminars selling dubious financial products, and high-pressure phone calls and endless junk mail peddling free vacation packages, sweepstakes, phony charity fundraisers and more.

And, of course, there's the ongoing problem of identity theft, Medicare fraud, door-to-door scams, credit card theft, Internet and e-mail scams and family thieves - which makes up more than half of all financial crimes against the elderly.

Fraud Protection

The most effective way to help protect your mom is to alert her to the different kind of scams out there that target seniors.

The easiest way to do this is by visiting the North American Securities Administrator's Web site (www.nasaa.org - click on Senior Investment Resource Center), where you can get a rundown on some of the most common scams making the rounds these days as well as a Fraud Awareness Quiz. Also see www.fraud.org.

If your mom doesn't have access to a computer, print out the materials yourself and use them to start a conversation.

It's also a good idea to keep tabs on her social circle. For example, are you hearing a

new name mentioned when you talk to her? Who's giving her advice, financial or otherwise? It's almost like checking up on your kids and who they're hanging out with. Introduce yourself to the new people entering your mom's life, just so they know you're involved with her affairs.

Some additional tips that can protect her include reminding her to never give out her Social Security number or financial information over the telephone, in person or over the Internet unless she initiated the contact. To consider using direct deposit rather than having paper checks (such as Social Security, disability or stock dividends) sent to her through the mail. And to register with the National Do Not Call Registry (www.donotcall.gov; 888-382-1222) which will reduce telemarketing scams.

Spotting a Scam

Helping manage your mom's money is the best way to spot potential scams. But be aware that this can be a very sensitive topic, so be as diplomatic and graceful as possible. The last thing you want to do is make her defensive, but even simple tasks such as looking over her financial statements can alert you to questionable checks or large withdrawals.

If she doesn't want you looking at her financial records, there are other clues, such as is she getting a lot of junk mail for contests, free trips, and sweepstakes? Is she receiving calls from strangers offering awards or moneymaking deals? Are there lots of cheap items lying around her house like costume jewelry, mini-flashlights or wristwatches, which she may be purchasing in order to win a contest - a common con artist lure.

Also notice if her spending habits have changed, if she has complained about being short of money lately, or has suddenly become secretive or defensive about her finances. All these may be signs of trouble.

Who to Call

If you suspect your mom has gotten scammed report it to your state securities regulator's office (visit www.nasaa.org to find yours). Even if you aren't sure, it's important to get regulators involved. They may be able to connect the dots in ways you can't.

Send your senior questions to: Savvy Senior, P.O. Box 5443, Norman, OK 73070, or visit www.savvysenior.org.

Jim Miller is a contributor to the NBC Today show and author of "The Savvy Senior" books.

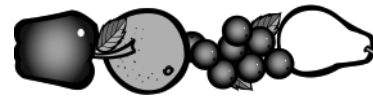

Display ads should be submitted to the DeQuincy News by 4 p.m. Monday for inclusion in that week's paper. Costs vary by size.

Classified ads should be submitted by 10 a.m. Tuesday of that week's paper. The cost is \$5.00 for the first 25 words, and 10¢ for each additional word.

Gospel Jam to be held Saturday, Sept. 22

Grand Lake Community Church, a Southern Baptist Mission, will sponsor a Gospel Jam, Saturday, Sept. 22, at 6 p.m. at the Fireman's Center in Grand Lake. Bible Study will be held Tuesday at

6:30 p.m. in the center. There will be free hot dogs and cold drinks. Call Bro. Mike Paris at 438-2313 for more information.



Callie Brevelle

Callie Brevelle ranked 'Elite'

The Kids Artistic Revue National Dance Competition was held in Panama City Beach, Fla. this past June. Callie Brevelle received an Elite Top 1st ranking with her jazz solo Shake-A-Tail Feather.

She also placed 10th overall in the competition as she competed with over 100 soloists in the 12 year and under age division. She also performed in five other group routines which all took over-all awards.

Callie is a member of the Tammy Palmer's Center Stage Dance Company. She has been dancing since she was 3 years old. She also enjoys tumbling and is a JV Cheerleader for the Grand Lake Hornets.

Callie is the eleven year old daughter of Mark and Laurie Brevelle. She is a 6th grade, 3-star student at Grand Lake School.

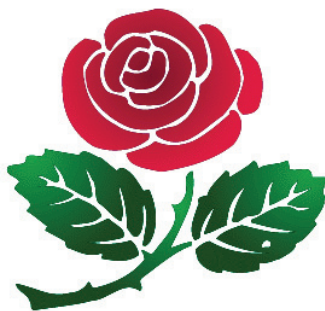

THE CAMERON BRANCH Library and Louisiana Spirit will host a youth program at the Cameron Branch Library each Friday from 11 a.m. to noon. Participants age 5 to 18 will take part in age-appropriate activities. They will learn coping skills and how to deal with stress while they are having fun at the library. Door prizes will be given. There is no charge. For more information call Dede at 775-5421 or Phyllis at 433-6460.

51st Annual Louisiana Fur & Wildlife Festival

Pageants - January 5, 2008 All pageants will be held in Lake Charles, La at the Lake Charles Civic Centers Rosa Hart theater.

January 11 & 12, 2008 All events will take place on the fairgrounds located at the old Cameron Elementary School grounds.

Music on the Fair Grounds - January 12th 3:30 - 6:30 p.m. - Jamie

Bergeron 6 - 9 p.m. - Barry Badon

Souvenirs for sale on fairgrounds and on Main Street: shirts, cookbooks, hats, koozies!

Join The Fun!

★ ★ ★ ★ ★ ★ ★ ★ ★ ★ ★ ★ ★ ★ ★ ★

ATTENTION

POLITICAL CANDIDATES

★ ★ ★ ★ ★ ★ ★ ★ ★ ★ ★ ★ ★ ★ ★ ★

Advertising space reservation and copy deadline for each week for the Cameron Parish Pilot is each Monday, 5 p.m. for the week your ad is scheduled to run. Political advertisements require pre-payment.

For advertising rate information log on to: www.dequincynews.com or please call Jeffra DeViney, Advertising Director at 337.912.5063.





★ ★ ★ ★ ★ ★ ★ ★ ★ ★ ★ ★ ★ ★ ★ ★



A PLACE CALLED HOME

A 64-page picture book featuring the photographs of Bill Turnbull

Through the lens of his camera, Bill Turnbull fixed in time colorful images of the beauty of the cheniers, beaches, marshes, swamps, and prairies of Cameron Parish. Taken between two of the worst natural disasters the area has ever experienced, Hurricane Audrey (1957) and Hurricane Rita (2005), Bill's photographs vividly remind us of the beauty that was and will be again. With an eye for detail that most of us hold only in our personal memory, he recorded the scenic beauty of the parish that for many years Bill and I were proud to call home.

To reserve your copy please send \$15.00 along with \$3.00 for shipping and handling (per copy) to Janie Turnbull, Turnbull Ink Press, P. O. Box 720447, Norman, OK 73070 by Sept. 15, 2007.

Yes, please reserve _____ copy/copies of: A PLACE CALLED HOME. I've enclosed a check/money order for _____

Name: _____

Address: _____

City, State, Zip _____

Please Print - Make Checks payable to Turnbull Ink Press

Johnson Bayou Rural Health Clinic Building Today for a Better Tomorrow

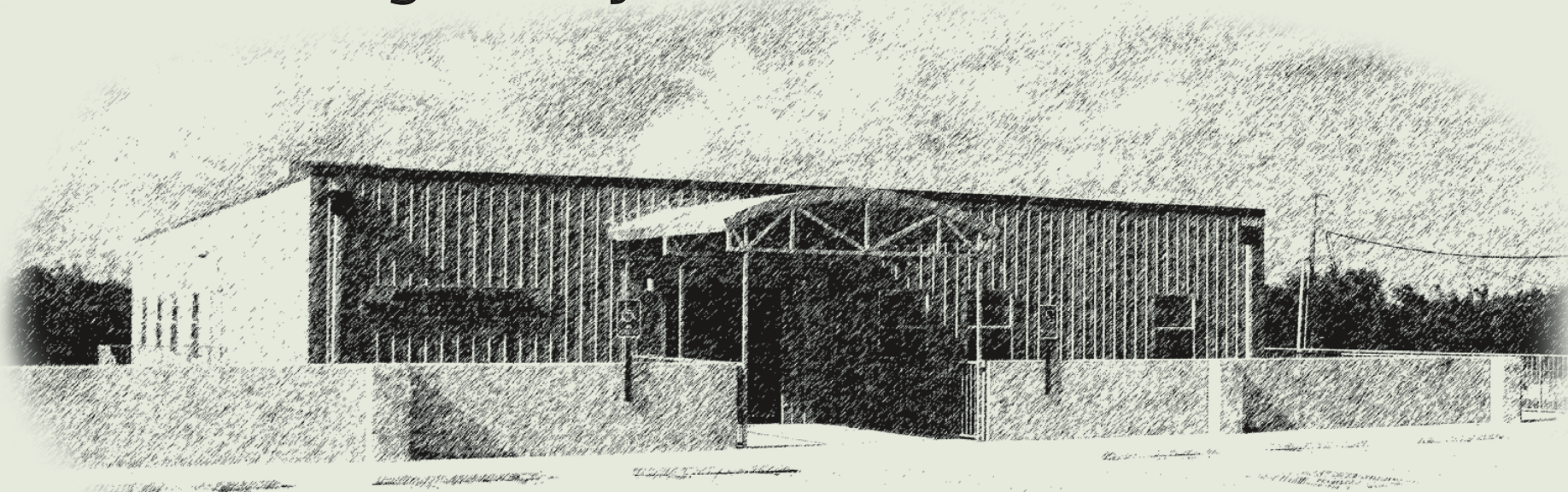

Johnson Bayou Rural Health Clinic
6240 Gulf Beach Highway
Johnson Bayou, LA 70631
(1/2 mile east of Johnson Bayou High School)

Date: 9-14-07
Time: 11:00 a.m. - 2:00 p.m.

Join Cheniere and the Stream Family for a special ribbon cutting to celebrate the dedication of the Johnson Bayou Rural Health Clinic. Refreshments and facility tours will follow the ceremony.

For more information contact:
Cindy.McGee@cheniere.com
337-569-2311

Hosted by: **CHENIERE**